probes

by bruno zuconi, president, Scala Radio Company
and martin clifford

published by gernsback publications, inc.
publishers of RADIO-ELECTRONICS magazine
25 west broadway, new york 7, new york

GERNSBACK LIBRARY BOOK NO. 54



copyright 1955, by
Gernsback Publications, Inc.
all rights reserved

Library of Congress Catalog Card No. 54-13280
cover and book format designed by muneef alwan

contents

chapter

page

1

Crystal demodulator probes

Classifications and advantages. Series and shunt detectors. Characteristics and requirements. Probe filter. Input voltage to probe. Probe input capacitance. Probe circuit time constants. Scope preamplifier. Grounding the probe. Interchangeability of probes.

7

2

Working with crystal probes

Signal tracing. Waveforms. Undershoot. I.f. gain and alignment. Single stage response. Buzz. Testing video amplifiers. Crystal diode voltage and current ratings. Adjusting a video amplifier. Ratio-detector curve. Calibrating a marker generator. Sweep generator output. Grounds. Waveform errors. Maximum signal voltage.

25

3

Voltage-doubler probes

Advantages. Voltage limitations. Peak-to-peak probe. Calibration of marker generator. Making ratio-detector S-curve. I.f. signal and sync buzz tracing. Color TV testing. Dead-stage indication, regeneration, sync buzz. Peak-to-peak voltage measurements. Frequency response. 60-cycle rejection.

51

4

Balanced probes

Impedance matching. Need for balanced probe. Transmission line impedance. Zero-volt reference line. Testing transmission lines. Mismatch between transmission line and antenna or TV input. Transmission line losses. Construction of balanced probe. Gain and response of TV boosters. Balun.

59

5

Low-capacitance probes

Circuit loading. Probe attenuation and design. Use of probe in high-impedance, high-voltage circuits and in circuits with high d.c. component. Probe response vs. scope response. Scope calibration. Adjusting and extending voltage range. Tracing the TV sync signal. High-voltage adapter. Building a low-capacitance probe.

75

6

High-voltage probes

Probe design and construction. How the probe works. Attenuation factor. Miscellaneous cables. Use with uncompensated scope. Behavior in 60-cycle circuits. 100-to-1 probe. Spotting flyback defects. Ripple in high-voltage supply. High-voltage buzz. Multiplication factor. Probe resistance. Safety precautions.

99

7

Isolation and direct probes

Isolation probe for v.t.v.m. Reasons for using isolation probe. Probe construction. Effect of probe on meter calibration. Using the probe with a multimeter. Using the isolation probe. Isolation probe for scope. Marker indication. The direct probe. Combined direct and isolation probe. Test leads.

123

8

Specialized probes

Audio tracer. Capacitor-tester. Hum probe. Frequency-compensated probe. Probe amplifier. A.f. and r.f. tracer. Miniature test probes. R.f. indicator. R.f. voltmeter probe. Quadrupler probe. Magic-eye probe. Plugs and connectors. Neon-bulb probe. Probe housing. Cathode-follower probe. Transistor probe.

137

9

The Chromatic probe

Probe circuit. Development of a wide-band sweep. Single-image response. Using the Chromatic Probe. D.c. voltage at video amplifier input. Testing color TV. Demodulator probe limitations. Chromatic Probe maintenance. Chromatic Amplifier.

165

10

Vacuum-tube probes

Transit time. Contact potential. High-frequency probe. Peak-to-peak probe. Cathode-follower probe. Using the cathode-follower probe. Grid-leak detector probe. Grid-dip probe. The grid-dip probe at work. Probe housing. Portable signal tracer. Signal tracer for AM, FM, and TV. Tube probe.

183

Supplement— Television waveforms

Examining TV waveforms. Input to grid of horizontal amplifier. Pulses at plate of a.g.c. amplifier. Video i.f. waveforms. Output of V.H.F. tuner. Wave at input to horizontal deflection coil. Video-amplifier waveshapes. TV wave in sync circuits. Wave at plate of vertical multivibrator.

207

introduction

A probe is a link. It is a device connected between a test instrument (usually a scope or v.t.v.m.) and a radio or TV set being repaired. The simplest type of probe can be nothing more than just a pair of test leads. Alternatively, it can be complicated to the extent that a complete detecting and amplifying system will be inside the probe housing. Although most probes are characterized by the use of few components and elementary circuit structure, yet the work they must perform is out of all proportion to their size. Because a piece of test equipment, such as a probe, is small or inexpensive, does not mean that it is unimportant or unnecessary. The finest v.t.v.m. or scope is limited by the kind of probe you use with such equipment and by your own knowledge of probes.

Regardless of the particular probe you use at any time, a probe has one job and one job only. A probe is supposed to bring the voltage or waveshape being measured or examined out of the receiver and into the test instrument. In effect, what you are doing is getting the voltage or waveshape that interests you out of the defective receiver and into the open where it can be more easily inspected.

There are a few requirements that are imposed on the probe. It must not load the circuit being checked. It should not reduce the voltage at the point under test. A probe can be used to measure a voltage, in which case the voltage must remain the same at the point being tested, with or without the probe connection. If a probe is used for waveshape analysis, it must pick up that waveshape and transfer it to your scope without making any change in the shape of that wave. And finally, since probes are used for making dynamic tests (that is, with the radio or TV set turned on and working) the probe must do nothing to disturb the set.

The number of probes you will need for your servicing work

will depend entirely upon you. Obviously, the ideal arrangement is to have a probe for each specific function. Although probes are comparatively inexpensive you can build your own if you wish, buy individual probes as you need them or else get a complete probe set. Again this is a matter for personal choice.

More than almost any kind of project, a technical book is a cooperative enterprise. Many persons and organizations were kind enough and gracious enough to make this publication a possibility. We acknowledge with thanks, assistance from these well-known companies: Admiral Corp.; Allen B. Du Mont Laboratories, Inc.; Browning Laboratories; Cornell-Dubilier Electric Corp.; Electronic Instrument Co., Inc.; Electronic Measurements Corp.; General Electric Co., Hickok Electrical Instrument Co., Jackson Electrical Instrument Co.; Linear Equipment Laboratories, Inc.; Magnavox Co.; National Bureau of Standards; Precise Development Corp.; Precision Apparatus Company, Inc.; Pres Probe Co.; Radio Corp. of America; RADIO-ELECTRONICS Magazine, Scala Radio Co.; Simpson Electric Co.; Supreme, Inc.; Sylvania Electric Products, Inc.; Tektronix, Inc.

Bruno Zucconi
Martin Clifford

crystal demodulator probes

There are many different probes. We have a.c. probes, r.f. probes, peak-to-peak probes, demodulator probes, detector probes, voltage-doubler probes, high-voltage probes, crystal probes, vacuum-tube probes, and numerous other types. Most of these names refer to the same kind of probe. Thus a peak-to-peak and a voltage-doubler probe are identical. A demodulator probe and a detector probe are the same. The name given to a particular probe may be decided by the manufacturer of the probe, by the manufacturer of your v.t.v.m. or scope, or by you personally. Actually, all probes may be considered as either rectifying, divider, isolating, or direct probes. All probes can be classified under these four general headings.

Test instruments are not used alone. They must, in some fashion or other, be connected to the radio or TV set being tested. Many worth-while articles and books have been written about the v.t.v.m. and the scope, but to get the most out of these instruments you must be equally familiar with various probes and cables. Although a probe is a detachable item and is often considered separate and apart from the test instrument, actually it is nothing less than an extension of v.t.v.m. or scope circuitry.

There are many instances in which the use of a probe is an absolute necessity. This is the case when you want to look at waveforms in TV sets and you do not want the connecting link (the probe) to add or subtract anything from the wave. Aside from this important fact, probes have many decided advantages.

For example, a probe can be used to extend the existing range or scale of a v.t.v.m. A high-voltage probe permits you to use your v.t.v.m. to test a picture-tube second-anode voltage, or any d.c. voltage higher than the usual two- or three-hundred encountered in a TV set. Similarly, properly designed probes will permit you to make measurements of r.f. voltages having frequencies up to several hundred (or more) megacycles.

The whole idea of a test instrument is to be able to measure a voltage or examine a waveform without reducing that voltage (or adding to it) or altering the waveform in any way. It is not enough just to connect your instrument to the circuit under test. This must be done in such a way that the circuit is not loaded and that the voltage appearing at the point of test is not changed.

Finally, probes help speed trouble shooting by enabling your test instruments to do the job for which they were designed.

Advantages of detector probes

A detector probe is a necessity. Such a probe allows you to put your v.t.v.m. or scope right across the test points in a radio or TV set. A detector probe will reduce the loading effect of your test instrument, will keep the circuit you are measuring steady and stable (will not throw it into regeneration or oscillation). A properly designed probe will enable you to make measurements without worrying about stray magnetic fields such as hum or noise (these are actually voltages which can interfere with your tests). While we do not worry too much about these factors at audio and low radio frequencies, they do become important just as soon as we get into circuits that are characterized by high-frequency operation (i.f. stages in TV sets, video-amplifier circuits, front ends, etc.).

Using detector probes

Signal tracing in TV receivers differs in several respects from signal tracing in radios. First, the range of frequencies found in TV circuits is very much broader than in radio. Second, the supply and signal voltages in a TV chassis cover a much wider range than in radio work. Third, the circuit impedances in TV receivers range from less than 1 ohm to as high as 10 megohms or more. Fourth, signal tracing in radios is usually concerned with sine-wave signals—such signals are the exception rather than the rule in TV. TV circuits often operate with two signals present at the same time, such as the FM sound and AM picture signals or 60-cycle vertical-sync and 15.75-kc horizontal-sync signals.

The operating frequencies in the r.f., i.f. and — under some conditions—in the video amplifier of a TV receiver are too high for the usual service scope to display directly. For this reason, signal tracing in the r.f., i.f. and video amplifiers requires *demodulator*, or detector, probes, which rectify the modulated waveform and recover the modulation envelope.

This can be illustrated by considering a modulated r.f. carrier whose frequency is 55.25 mc, while the modulation envelope represents a frequency (at a particular instant) of perhaps 1,000 cycles. Here the demodulator probe makes it possible for the scope to display the 1,000-cycle output, although, of course, the scope cannot reproduce the modulated 55.25-mc carrier.

Fig. 101 shows what the technician will see when a sine wave is removed from the modulated r.f. carrier through the use of a demodulator probe.

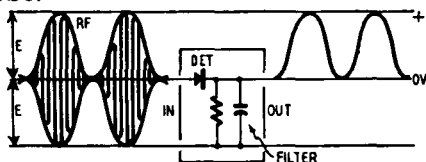

Fig. 101. A modulated wave can be rectified by a crystal-detector probe. The low-frequency wave can be seen on the scope.

When used in a high-frequency circuit, the crystal demodulator probe separates the modulating signal from the r.f. carrier. The lower-frequency wave, or modulating signal, is then fed to the vertical input of a scope. When the scope is set up for observations on a.c., the waveform seen on the scope tube will be centered vertically on the zero axis of the screen. If the scope is set up for observations on d.c., the waveform will be displaced vertically, the amount of displacement being proportional to the amount of d.c. resulting from rectification of the r.f. carrier.

Demodulator probes are usually built around crystal-diode detectors, because these devices are compact, have good frequency response and do not require a source of heater voltage. Crystals used in popular commercial crystal demodulator probes are units such as the 1N32, 1N34A and 1N48.

Practical crystal demodulator probes usually have moderate sensitivity, an input capacitance approximately equal to that of a picture tube and a time constant suitable for demodulating carrier frequencies which have been modulated by frequencies as low as 60 cycles.

Series and shunt detectors

Both series and shunt type detectors (see Fig. 102) are used in commercial probes, but the series type is the more sensitive for signal-tracing purposes. The series probe is the least suitable for video-amplifier testing and will seriously distort the sweep-output waveform.

Shunt type probes are generally found most suitable for signal tracing as well as for video-amplifier checking. Both series and shunt type probes use series resistors to prevent the scope input capacitance from shunting the crystal detector and reducing the output. The circuit for a signal tracing, shunt-type demodulator is shown in Fig. 103. An exploded view of a typical commercial probe appears in the photo (Fig. 104). The specifications for this probe are listed in Table 1.

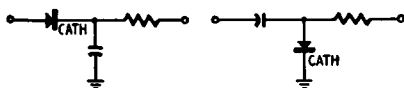

Fig. 102. Series (left) and shunt (right) detectors. The series resistor prevents the scope input capacitance from shunting the detector and reducing the output.

Table 1—CHARACTERISTICS OF DEMODULATOR PROBE

Frequency Response Characteristics:

R.F. Carrier Range	500 kc to 250 mc
Modulated-Signal Range	30 to 5,000 cycles
Input Capacitance (Approx.)	2.5 μf
Equivalent Input Resistance (Approx.):	

At 500 kc	25,000 ohms
At 1 mc	23,000 "
At 5 mc	21,000 "
At 10 mc	18,000 "
At 50 mc	10,000 "
At 100 mc	5,000 "
At 150 mc	4,500 "
At 200 mc	2,500 "

Maximum Input:

A.c. Voltage	20 r.m.s. volts
	28 peak "
D.c. Voltage	500 "

Crystal probe requirements

A crystal probe used with a scope must possess several special features. Unlike a probe for use primarily with a v.t.v.m., it must rectify the r.f. component of the signal and it must pass the modulation envelope of the signal into the vertical amplifier of the

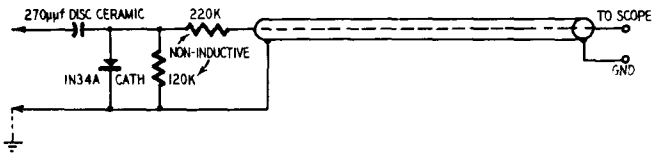

Fig. 103. Circuit of signal tracing demodulator probe.

scope. Accordingly, a scope probe must have certain filter characteristics determined by the service applications for which it is designed. For example, for use in video-amplifier adjustments, the probe must not only completely rectify and filter video frequencies from 100 kc to 4.5 mc, but it must also pass, undistorted, the square waves which form part of the composite video signal. For application in i.f. signal tracing, the probe must have a relatively high input impedance over a frequency range covering ap-

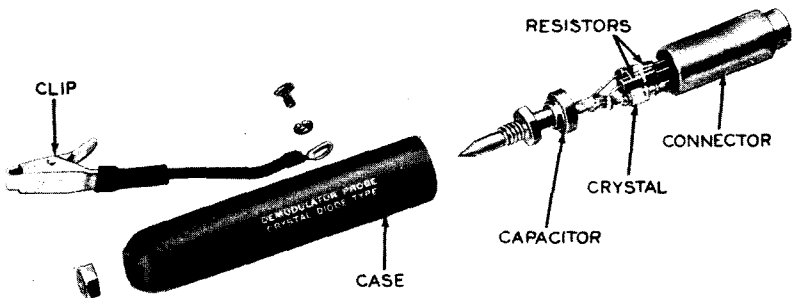

Fig. 104. Exploded view of crystal diode type demodulator probe. The characteristics of this probe are given in Table 1 on page 10.

proximately 20 to 45 mc. For application in testing the output of a conventional sweep generator, the probe must be flat up to 225 mc.

Because the probe must be used in cramped spaces, it must be well insulated to avoid shorts. Such a probe is used to display a.c.

waveforms in the presence of relatively high d.c. voltages and hence suitable high-frequency blocking capacitors are needed in its construction. The crystal diodes in such probes must not only have a high front-to-back ratio, but must also accommodate reasonably high a.c. signal voltages without loss of sensitivity or burn-out.

The crystal probe should be designed for demodulation of complex waveforms such as vertical blanking pulses and other pulses normally encountered in TV receivers. This is accomplished by the proper relationship between the resistive and capacitive components in the probe. Use of a selected high-impedance crystal diode and short lead lengths will make the probe useful as a demodulator at frequencies up to 1,000 mc.

Like all probes, the demodulator should be shielded to prevent erroneous response due to body capacitance. Shielding is also needed to avoid stray fields which might be present near the probe head as a result of the strong 60-cycle and 15.75-kc magnetic fields surrounding a TV chassis. Signal tracing in a TV i.f. amplifier with a crystal demodulator probe is illustrated in the photo (Fig. 105).

Input voltage to the demodulator probe

The amount of r.f. input voltage to the demodulator probe is determined by the type of crystal used in the unit. For a probe using a 1N34A the maximum r.f. voltage input is approximately 20 r.m.s. or 28 peak volts. The probe will often be placed in a circuit having both d.c. and a.c. voltages. Generally speaking, you should not put the probe at any point having a potential higher than 250 volts d.c. If it is necessary to measure higher values of r.f. voltage than those ordinarily found in radio and television sets, then a vacuum-tube type demodulator probe should be used. The crystal demodulator probe does have the advantage of not requiring filament voltage, is not as bulky as the tube type demodulator probe and does not have contact potential. For a description of contact potential, what it is and how it is minimized or eliminated, turn to the section on vacuum-tube probes, Chapter 10.

Input capacitance of the probe

A considerable portion of the utility of a crystal demodulator probe is determined by the input capacitance of the probe and

the frequency at the point of test. The amount of probe input capacitance becomes increasingly important as the frequency goes up. An input capacitance of 20 μf , not too serious at audio frequencies, is intolerable at the frequencies of TV i.f. stages. Where the probe has an input capacitance of less than 3 μf , it can be used in critical r.f. circuits without too great a detuning effect.

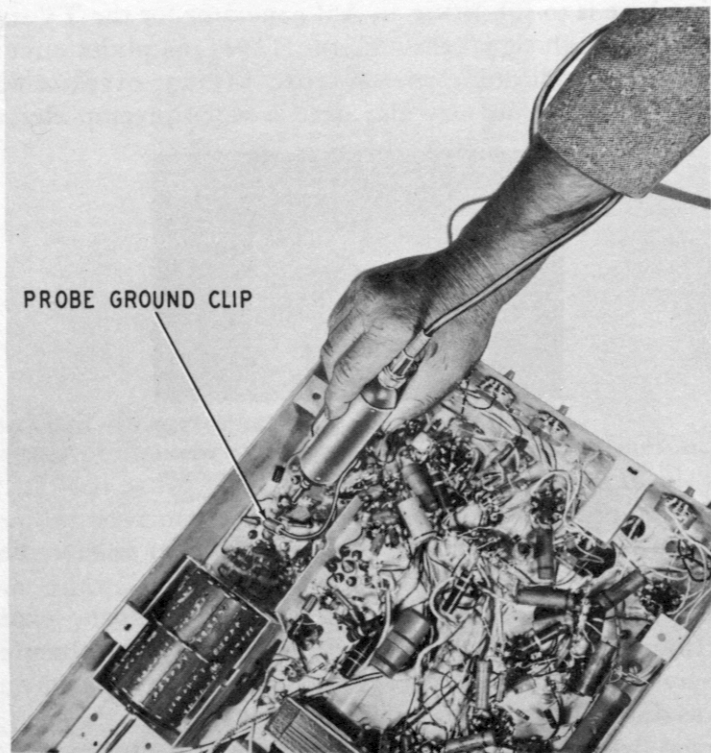

Fig. 105. Signal tracing in a TV i.f. amplifier with a crystal demodulator probe. Note probe ground clipped to chassis as close as possible to signal take-off.

If, for example, the crystal demodulator probe has a shunt capacitance *lower* than that of a picture-tube grid circuit, it can be connected to the output of a video amplifier without seriously disturbing the circuit.

Which probe?

The specific probe needed for any trouble-shooting job depends on the type of signal to be traced. This, in turn, depends on which circuit of the receiver is under test and whether or not the receiver can supply its own test signal.

For example, in servicing a TV receiver, if a normal TV station signal can be traced, the video-signal waveform displayed on the scope screen should look like Fig. 106. (In this case the scope sweep was set at 60 cycles, with internal sync, to show one vertical blanking and sync pulse.) On the other hand, if the TV signal is weak, the scope trace may be too small to be useful. The only solution here is to substitute an AM generator for the TV station, and drive enough signal through the TV i.f. amplifier circuits to give a usable indication on the scope without overloading the receiver circuits. You may also need a scope preamplifier when

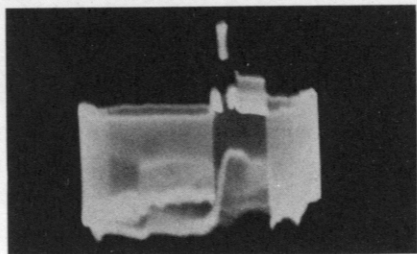

Fig. 106. Scope display obtained when signal-tracing i.f. amplifier with crystal demodulator probe. The pattern consists of the reproduced TV station signal.

working in low-level circuits. Such an amplifier is described in this chapter.

Even with comparatively strong generator signals, excessive hash from stray fields around the TV chassis may obscure the scope trace unless the probe is provided with a shielded output cable as shown in Fig. 107.

Crystal demodulator probes can be given various response characteristics, either for better waveform reproduction or greater sensitivity or to provide a better impedance match for certain tests. As an instance, the video waveform in Fig. 106 can be seen in better detail (Fig. 108) by using a probe with less sensitivity but better frequency response. Fig. 108 is a much more accurate picture of the vertical blanking interval. However, the TV technician is usually more than willing to sacrifice fidelity of waveform to get increased sensitivity for probing in low-level circuits like the mixer and first i.f. stages.

A crystal probe designed for maximum sensitivity may be ideal for simple signal tracing, but it will not be suitable for checking video-amplifier response, or observing critical waveforms in sweep

and high-voltage circuits. Since the technician usually does not want to invest in several specialized probes for different applications, commercial probes generally represent compromise designs which will meet the greatest number of application requirements in a satisfactory manner.

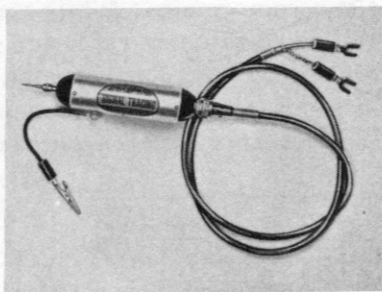

Fig. 107. Probe and output leads must be shielded to prevent pickup of undesired signals.

Probe-circuit time constants

A crystal probe which is to be used for video-amplifier adjustments, as well as for signal tracing, must be able to display 60-cycle square-wave modulation on the scope screen without appreciable distortion. The ability of a probe to pass a square wave without distortion depends upon the values of resistance and

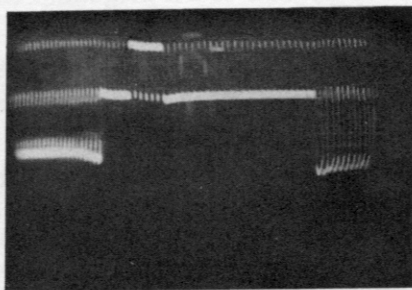

Fig. 108. The vertical-blanking interval of Fig. 106 shown in greater detail.

capacitance in the probe, the capacitance of the connecting cable and the input capacitance of the scope. However, you will find it much easier if you will consider the entire probe, from its tip to the input of the scope, as a single resistor and capacitor. The ability of the probe to pass a square wave without clipping de-

depends upon the speed with which this capacitor will charge and discharge. This is determined by the size of the capacitor (its capacitance) and the amount of resistance. The smaller the capacitance and the lower the value of resistance, the faster will the charge and discharge actions take place.

Building a probe is a compromise. While we want the values of R and C to be small, fixed values of cable and scope input capacitance are design limiting factors. Furthermore, R1 (in Fig. 109) cannot be made too small, since it will then permit r.f. to get into the scope. If the resistance of R2 is seriously decreased, the

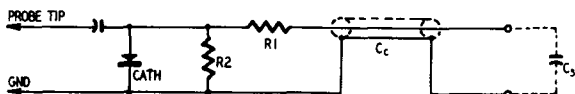

Fig. 109. Probe circuit RC time constant.

crystal will be shorted or else the signal voltage developed across R2 may be made too weak to feed into the vertical input of the scope.

The product of resistance and capacitance is known as a time constant, and is expressed by the very simple formula, $T = R \times C$. With the resistance (R) expressed in megohms, the capacitance (C) in microfarads, the time (T) is in seconds. The time constant is independent of the amount of voltage applied. For example, a capacitor of 0.05 μf connected to a 2-megohm resistor will charge in 0.10 second ($T = 2 \times 0.05$). The capacitor actually charges only to 63.2% of the applied voltage; but for all practical purposes, the capacitor is considered to be fully charged.*

Scope preamplifier

Because of the relatively low sensitivity of average service type scopes, most of which require a minimum input of 20,000 microvolts, a preamplifier must be used in conjunction with a demodu-

*As seen in Fig. 109, the limiting factor in the ability of a crystal probe to display a modulation envelope on the scope screen is usually determined by the time constant of the scope input circuit, $(C_c + C_s) \times (R_1 + R_2)$. The total input capacitance $C_c + C_s$ charges through R1 and discharges through R1 + R2. Unless this charging and discharging can take place with sufficient rapidity, there will be negative peak clipping of the waveform displayed on the scope screen. The time constant can be reduced by decreasing the value of C_c . Cable capacitance C_c is usually much larger than scope input capacitance C_s . In a single time-constant interval, the cable can charge up to 63.2% of the peak value of a square wave or, having been previously charged, will be able to discharge in a single time-constant interval to 36.8% of the peak value of the initial charge.

lator when tracing waveforms in TV tuners, low-level i.f. stages, TV boosters, etc., unless an unusually strong signal is available at the antenna terminals. Such an amplifier should have a very low hum level and a frequency response essentially flat from 30 to 500,000 cycles, with a gain of at least 25. Another point with regard to the preamplifier (often overlooked but a *must* for good TV tracing) is that the amplifier must have minimum phase shift.

It is true that an alert technician can overcome the handicap of a weak signal by substituting the output of a sweep generator

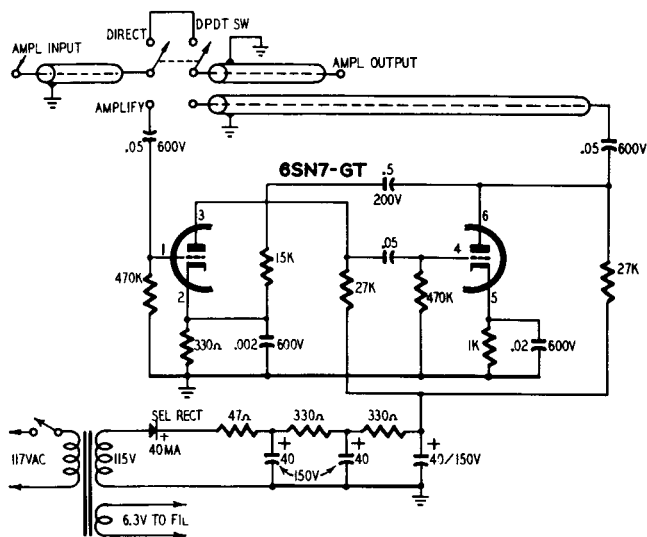

Fig. 110. Circuit of preamplifier that can be used with a demodulator probe for tracing in low level stages. Gain characteristics are listed in Table 2, page 18.

for that of the television signal. Although a sweep generator can be used for this purpose, and although it will show the gain and frequency response characteristics of the tuner and i.f. amplifier, the composite video signal of the television station also shows sync pulses and video information.

The amplifier shown in the diagram (Fig. 110) is well within the described specifications. Because of the difficulty and expense involved in building a good compensated attenuator, no gain control is included in the circuit. Instead, the amplifier depends on the compensated vertical attenuator in the scope. This amplifier will handle up to 0.5 r.m.s. volt without distortion. When analyzing signals having an r.m.s. value greater than this, flip

switch S1 to the bypass position. The signal will then be coupled directly to the scope input.

The gain characteristics of the scope preamplifier are shown in Table 2. All voltages listed are r.m.s. values.

Table 2—GAIN CHARACTERISTICS OF SCOPE PREAMPLIFIER

Frequency	E_{in}	E_{out}	Gain
30 c.p.s.	0.6	18	30.0
100 c.p.s.	0.6	17	28.4
1 kc	0.6	16.5	27.5
10 "	0.59	17	28.9
20 "	0.59	17	28.9
50 "	0.58	17	29.3
100 "	0.57	16	28.1
200 "	0.57	15	26.5
300 "	0.57	15	26.5
500 "	0.58	15	26.0
600 "	0.58	11	19.0
700 "	0.58	9	15.5
800 "	0.58	8	13.8
900 "	0.58	7	12.0
1 mc	0.58	5	8.6

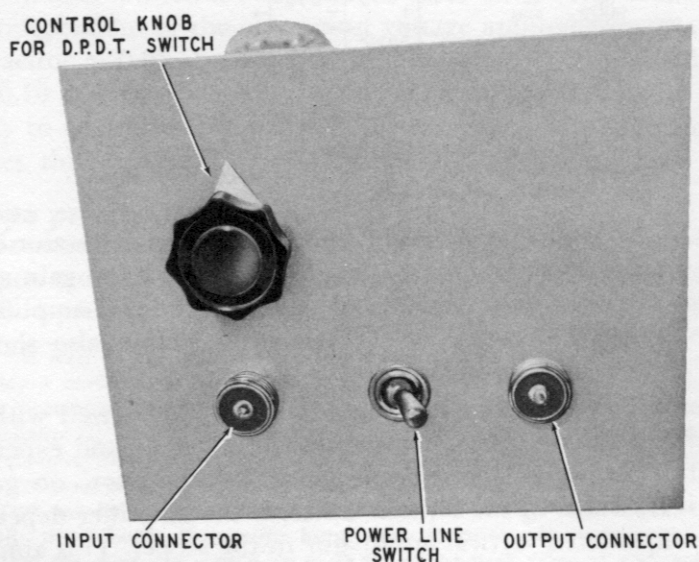

Fig. 111. Front panel view of the preamplifier. Turn the power switch on, the control knob to left or right, and the unit is ready without further adjustments.

The photographs in Figs. 111 and 112 show front and bottom

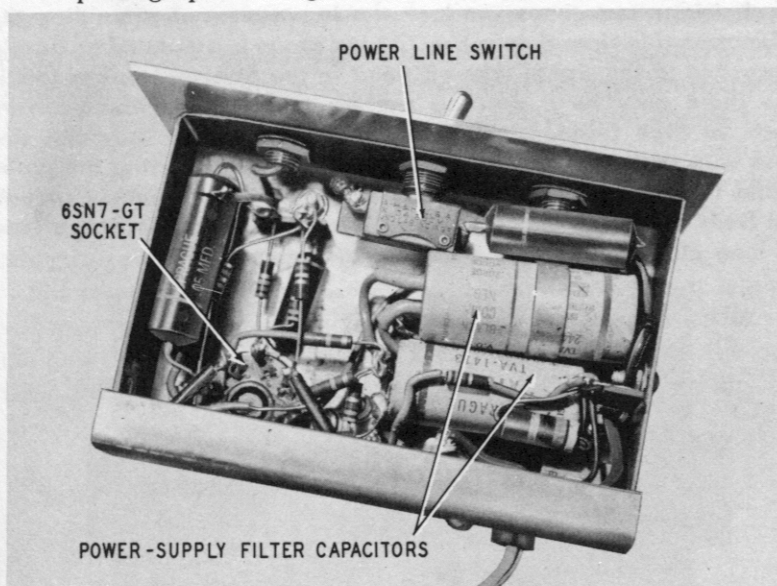

Fig. 112. Under-chassis view of the preamplifier. Compact arrangement means short leads, quick assembly.

views, respectively, of the preamplifier, while a rear view is illustrated in Fig. 113. The simplicity and compactness of the pre-

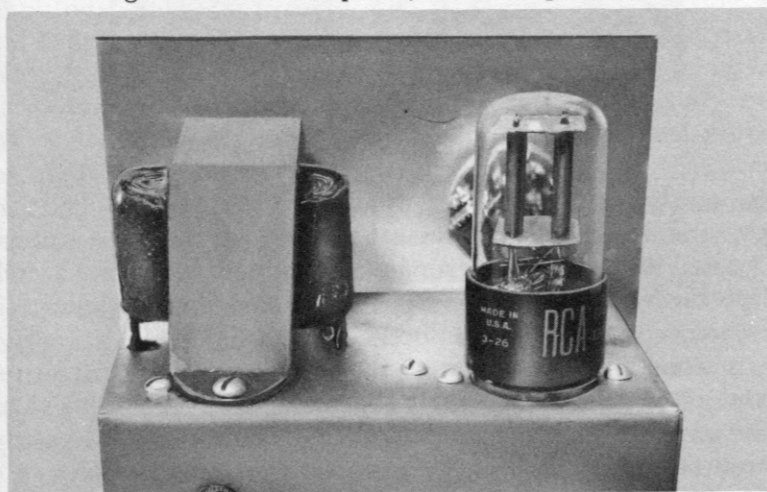

Fig. 113. Top view of the preamplifier. Either an open- or shielded-type power transformer can be used. Amplifier uses but a single tube.

amplifier is evident in Fig. 114, which shows the preamplifier being used with a crystal probe and a scope in TV servicing.

Grounding the probe

Technicians sometimes overlook the importance of grounding the probe correctly. Note that in Fig. 105 the probe is grounded as closely as possible to the signal take-off point in the receiver. Unless this is done there may be a spurious pattern because of ground-current effects at high frequencies. Many technicians think they can dispense with the annoyance of connecting and disconnecting the probe ground in i.f. signal tracing simply by running a permanent ground lead from the scope case to the receiver chassis. In practice, a lead this long almost invariably causes erratic operation.

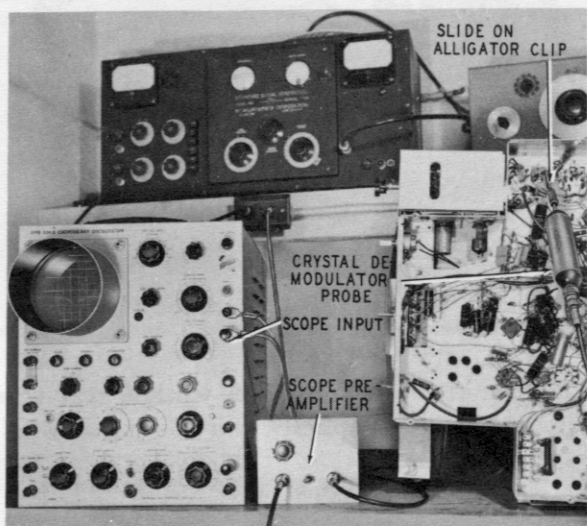

Fig. 114. Even with high sensitivity lab scopes it is necessary to use a preamplifier when tracing weak signals in low level TV i.f. stages.

Scope or v.t.v.m.?

A crystal demodulator probe can be used with either a scope or a v.t.v.m. While both instruments have their place on a well-equipped service bench, the scope does have some advantages in television repair work.

In a television set, there are a number of circuits designed just for the job of producing complex waveshapes or amplifying them. These wave shapes are asymmetrical. This means that the positive portion of such a wave is not a duplication or mirror-image of the negative half. A sine wave is a symmetrical wave. So is a square wave. In waves such as these, there is a very simple relationship between the average, r.m.s. (effective) and peak values. This is not true of the complex waves found in TV sets.

Both the amplitude and shape of TV pulses are important. In TV, the operations of triggering, scanning and synchronization depend upon the peak-to-peak amplitudes of waveforms, a few of which are shown in Fig. 115. By using a properly calibrated scope, you can measure such voltages and observe waveshapes simultaneously. A v.t.v.m., on the other hand, whether calibrated in terms of r.m.s. or peak voltage, is based upon the sine wave; hence readings of other types of waveforms do not necessarily reflect true values.

The crystal demodulator probe uses a single crystal: it is a true half-wave rectifier. This means that the crystal will rectify only one half of the input waveform and will reject or block the other half. This is perfectly satisfactory if you are measuring any type

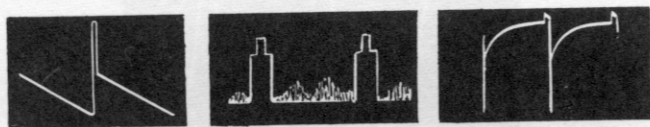

Fig. 115. A properly calibrated scope will enable you to measure the amplitudes of these TV waveforms.

of modulated wave, since the positive and negative portions of the modulated wave will be approximately the same in shape and amplitude. This is not true of the pulses used for triggering, sync and deflection in TV sets. Do *not* use a half-wave type, crystal demodulator probe (or half-wave vacuum-tube diode) to measure the peak-to-peak voltage of such waveforms. Technically speaking, you could use the half-wave demodulator for such measurements, but there are a number of very serious factors that prevent practical application. For peak-to-peak tests with a demodulator probe, you would have to make a measurement and then turn the crystal around so that you could measure the other half of the wave. Aside from the fact that it is inconvenient and impractical to do this, the impedance of a crystal is high in one direction, low in the other. By reversing the crystal (turning it around) you will change the characteristics of the probe and will seriously load the circuit under test.

Crystal probes of any type should be used only for measurements in radio-frequency, intermediate-frequency, audio or video-amplifier stages of radio and TV sets. It is dangerous to use crystal probes in sweep circuits of TV sets, since most pulse voltages are much higher than the maximum operating voltage of the

crystal. Contact with such voltages will immediately burn out the crystal.

You can make correct peak-to-peak measurements with a voltage-doubler vacuum-tube probe. This type of probe is described in Chapter 10.

There should never be any question in your mind as to which test instrument you should have on your service bench, v.t.v.m. or scope. Very definitely you should have both. However, it is not enough just to buy the instruments. You should know exactly what each one can or cannot do. As an example, consider the waveform shown in Fig. 116. A v.t.v.m. indicates the voltage of

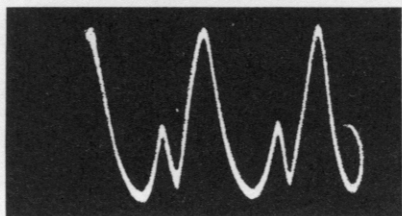

Fig. 116. Waveform with two components. A v.t.v.m. can indicate the voltage of the larger component, but does not reveal the presence of the smaller one.

the larger component, but does not reveal the presence of the smaller one. Examine also the typical beam-power tube circuit shown in Fig. 117. A crystal probe and v.t.v.m. could be used to check the gain of the stage. Suppose, however, the screen bypass capacitor is open as indicated by X on the circuit diagram. This means that the screen will try to act as a plate, and a signal voltage will be developed across the screen-dropping resistor. A scope placed across the screen-dropping resistor will show the presence of the signal, revealing inadequate bypassing, or, as in this case, no bypassing at all. This would not be indicated by a v.t.v.m.

While a single-diode scope type probe can be used with a v.t.v.m. as well as with a scope, its performance will differ from that of a probe designed for v.t.v.m. use only. If the output of the probe is connected to the d.c. volts input of the v.t.v.m., the scale of the v.t.v.m. will then indicate positive peak (not peak-to-peak) volts for a.c. signals having frequencies between 100 kc and 200 mc. If a modulated r.f. signal is applied to the crystal probe, the v.t.v.m. will indicate the positive peak voltage of the modulated

wave. The probe may load high-impedance circuits, especially at high frequencies, and tests should be made in low-impedance circuits whenever possible.

Interchangeability of probes

Although a particular probe may have a connector enabling you to fasten the probe to your v.t.v.m. or scope, it does not follow automatically that the probe is suitable for use with your particular test instrument. This is true even though you may have noted from the various circuits given in this chapter that most crystal demodulator probes have fairly similar design.

You can get probes in any one of three different ways. You can make the probe yourself. If you do, then you must consider the input characteristics of your v.t.v.m. or scope. Since a probe is a

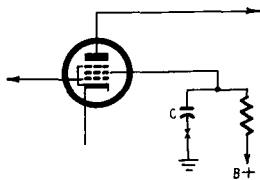

Fig. 117. Beam-power tube circuit with open screen bypass capacitor.

comparatively inexpensive test device, most service technicians buy theirs from companies that make a specialty of manufacturing them. Usually enough information is supplied with such probes to enable you to decide whether or not the probe can be used with your test instruments. Finally, some test-instrument manufacturers supply probes with the testing units they make. Naturally, in such cases you need have no concern about the suitability of the probe to the instrument.

Although in this chapter we have covered crystal detector probes only, demodulation (or detection) can also be had with a vacuum tube. Vacuum-tube demodulator probes are also known as r.f. probes. There are advantages and disadvantages for each probe, crystal or vacuum tube. Crystal probes are much more compact, require no filament heating power, are free from contact potential. There is some signal loss with either crystal or vacuum-tube diode type. However, there is signal gain with a vacuum-tube probe that uses a triode or pentode. The maximum peak voltage that you can apply to a crystal is less than 30. The vacuum-tube probe

can handle much higher voltages. While vacuum-tube diodes permit you to use higher input signal voltages than crystals, constant progress is being made in the field of semiconductors (crystals) so that ultimately this advantage may be overcome. The vacuum tube is a much more reliable unit over long periods of operation, since it is not as temperature-sensitive as a crystal. Also, it is possible to design vacuum-tube probes which have a higher input impedance than do crystal units.

Both types of probes, crystal and vacuum tube, are in use today. It makes little difference which you use just so long as you recognize the limitations of each. In any case, whether you use a crystal or vacuum-tube diode, the function is the same — rectification of the input signal.

working with crystal probes

Although the crystal probe is characterized by extreme simplicity, it is an extremely important and vital link between the defective receiver and the test equipment. For this reason the service technician must know both its limitations and capabilities, how to use it with maximum skill, how to avoid damaging it and, finally, the servicing techniques than can be used in conjunction with the crystal demodulator probe.

There are many jobs a crystal demodulator probe can do. It can be used for signal tracing in r.f., i.f. and video-amplifier cir-

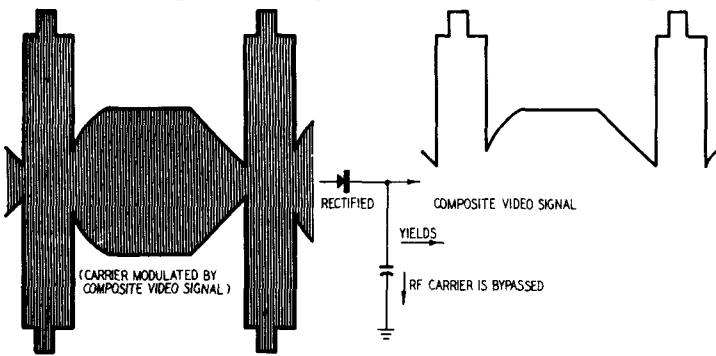

Fig. 201. The crystal in the probe removes one-half of the entire signal, consisting of the modulating signal and the r.f. carrier. The carrier is bypassed by the capacitor. The output is the original modulation voltage.

cuits, for buzz analysis in 4.5-mc amplifiers, or in the sound i.f. amplifier strips of split-sound TV sets, for ratio-detector marking.

It can be used for marker-generator calibration, for stage-by-stage alignment. You can use it whenever you need to detect a signal, just so long as you do not exceed the voltage rating of the crystal.

The illustration (Fig. 201) clearly represents the detector action of a crystal demodulator probe. Although we show here a video-modulated carrier, the same idea applies to an r.f. carrier modulated by an audio signal. In this illustration, the high-frequency r.f. carrier, modulated by the composite video signal, is detected or rectified by the probe crystal. The much higher frequency r.f. carrier is bypassed to ground, with the result that the original composite video modulating signal is fed into the scope. Actually, this is the same sort of action that takes place in the video second-detector circuit of a TV receiver.

Crystal demodulator probe action in an AM receiver is illustrated in Fig. 202. The r.f. carrier, modulated by an audio signal,

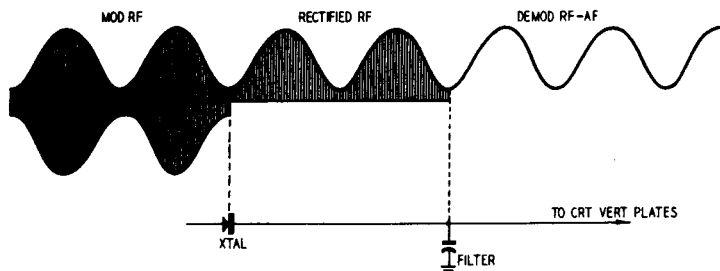

Fig. 202. Crystal demodulator probe action in an AM receiver. The crystal detector rectifies the signal and the capacitor removes the remainder of the original r.f. carrier.

is rectified by the crystal. The high-frequency r.f. is then bypassed while the original modulating signal is sent into the scope.

The size of filter capacitance in a probe is a design problem. If the capacitance is too large, a substantial portion of the modulating signal will be bypassed, lowering the input level to the scope or v.t.v.m. Excessive filtering will also bypass the high-frequency components of a pulse signal, resulting in a distorted waveform. If the capacitance is too small, filtering action will be poor and excessive r.f. carrier voltage will be fed into the scope. The effect of this r.f. voltage on the scope trace is described later in this chapter. A well-designed crystal probe should have low capacitance, high impedance.

Radio servicing with the demodulator probe

With a demodulator probe, a scope can be used to trace a modu-

lated r.f. signal at any frequency up to 500 mc through a radio or television receiver from the antenna post through to the detector or discriminator. This is a practical and quick method of trouble shooting.

Tune the receiver to some frequency within its range (for example 1,000 kc) and adjust the signal generator to produce a 1,000-kc amplitude-modulated signal. Feed the signal generator in at

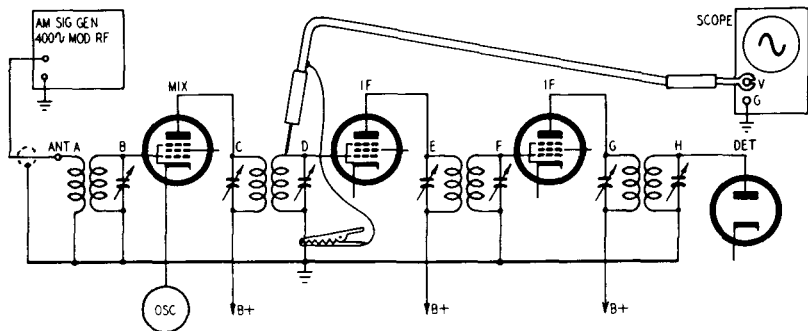

Fig. 203. Technique for stage-by-stage signal tracing in an AM receiver using a crystal demodulator probe.

the antenna post. Connect the crystal demodulator probe to the vertical input of the scope. The following checks can be made on the receiver by referring to Fig. 203.

WITH PROBE AT	CHECK
A	output of signal generator
B	r.f. transformer
C	1st detector or mixer tube
D	1st i.f. transformer
E	1st i.f. amplifier tube
F	2nd i.f. amplifier transformer
G	2nd i.f. amplifier tube
H	last i.f. transformer

Signal tracing

Signal tracing in a TV receiver is quite similar in technique to signal tracing in an ordinary AM set, except that for TV we are much more concerned with waveshapes. When using a crystal demodulator probe, you can check anywhere from the front end to the picture-tube input. If you have a receiver that has a raster but no picture, you can go successively from the front end, through the picture i.f.'s, video-detector and video-amplifier

stages, right up to the cathode or control grid of the picture tube (depending on which of these two elements is the signal electrode). Or you can reverse the procedure and work your way back from the output (picture tube) to the front end. The only requirement is that the signal must be strong enough to give satisfactory deflection on the scope screen. Generally you will find it necessary to use a sweep generator when signal tracing the front end.

Signal tracing is often thought of only in connection with finding a dead stage. However, signal tracing can do more than just that. You can also use it to find a *weak* stage or one that is in a regenerating or oscillating condition. Finding a weak stage is quite easy. The output signal of a tube should be greater than the input. The *amount* of gain per stage will depend on such

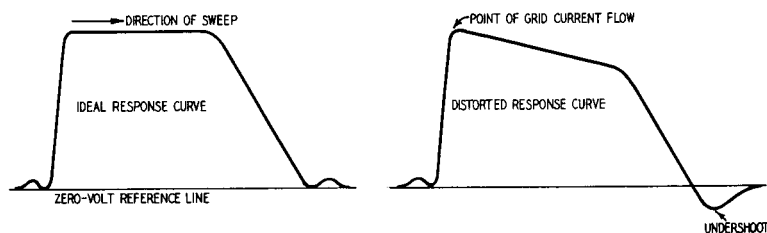

Fig. 204. The picture at the left shows an ideal response curve. If there is positive feedback in the stage, the curve may be distorted or exhibit undershoot as in the illustration at the right.

factors as type of tube used, amount of load, bias, etc. If the output is the same as the input (or less), then the stage is weak. Of course, this does not apply to a circuit such as a cathode follower where the output is always less than the input. A stage that is completely dead will show a waveform on the scope when the probe is placed on the control grid, but no waveform at all when it is placed at the plate.

The waveforms produced by a regenerative stage will depend upon whether you are using a TV station or a sweep generator as the signal source. If you use a sweep generator, you will find that the response curve of a regenerative stage will be very large either in the middle or at one end but will taper off sharply for the rest of the curve. If the amount of feedback in the regenerative stage is quite strong, you may even see false markers appearing in the sweep curve. With sufficient feedback, a stage may go into oscillation, in which case the curve may be torn apart or may exhibit undershoot, as illustrated in Fig. 204. This drawing shows the

development of undershoot distortion in an i.f. curve, caused by grid-current flow in a first video amplifier.

When a tube is forced into oscillation, the control grid is made positive and draws current. This flow of current then counteracts the positive charge on the grid, driving the grid into a strongly negative region. If there is capacitance between grid and ground, as is often the case, the charge resulting from grid-current flow through the grid-return resistor will hold the tube cut off for a length of time dependent upon the amount of capacitance and resistance in the grid circuit. A tube in this condition often resembles a dead circuit; in fact it is so for as long as the tube is cut off.

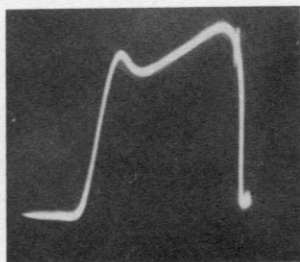

Fig. 205. A typical scope pattern observed when tracing a sweep signal through the input stages of a TV i.f. amplifier.

If you are using a TV station instead of a sweep generator as your signal source, feedback or regeneration will distort the composite video signal. The equalizing pulses will show up on the scope as smaller in amplitude than the vertical sync pulses, or you may get severe overshoot and ringing along the top of the vertical sync pulse.

I.f. gain and alignment

In simple signal tracing with a crystal demodulator probe, the technician is interested only in the relative change in the height of the pattern from stage to stage. Tests are ordinarily made by moving the probe from plate to plate, rather than from grid to grid, since plate circuits usually have lower impedance than grid circuits and are not loaded down by the probe to the same extent. The ratio of the pattern height observed from grid to plate of a stage is an indication of the gain of the stage, at the frequency of test.

When tracing a *sweep signal* through an i.f. amplifier (for

alignment), the scope should show a pattern like Fig. 205 or Fig. 206. (The over-all selectivity is poorer in the early i.f. stages and the pattern occupies a greater horizontal span on the scope.) It is a common error to assume that a pattern like Fig. 205 always represents a true single-stage or two-stage response. Actually, the true response of a single stage or a series of stages cannot be obtained unless the crystal probe is applied *across the plate load* of the last tube and this plate load must be made *nonresonant* by shunting the tuned circuit with a 200- or 300-ohm resistor. Curves like Fig. 205 or Fig. 206 which are obtained by merely applying

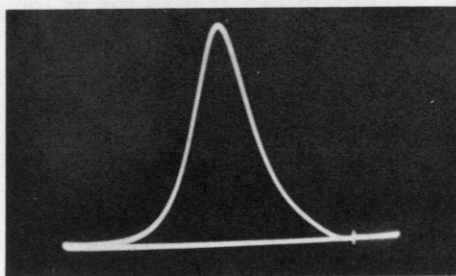

Fig. 206. Sweep-signal trace produced in the output stages of an i.f. amplifier.

the crystal probe at the grid or plate of an improperly loaded tube have little value for accurate alignment work. Special low-impedance probes are available which automatically provide the required circuit loading.

When aligning a TV set you may find that moving the output cable of the signal generator, or touching the cable with your hands, changes the pattern you see on the scope. This is an indication that the signal generator is not properly terminated, or else the impedance of the generator does not match the impedance of the points under test. Sometimes both conditions can exist, causing standing waves on the signal generator cable and resulting in distortion of the pattern on the screen. The cure is to insert a matching pad between signal-generator cable and receiver. Such pads are available commercially. A visual alignment setup is shown in Fig. 207. Read, also, the section on standing-wave distortion given on page 48.

Locating a dead stage

To locate a dead stage, apply a modulated r.f. signal into the antenna posts of the receiver. If a fairly strong TV signal is avail-

able from the antenna, it can be used for this purpose*; otherwise the modulated output from a signal generator should be

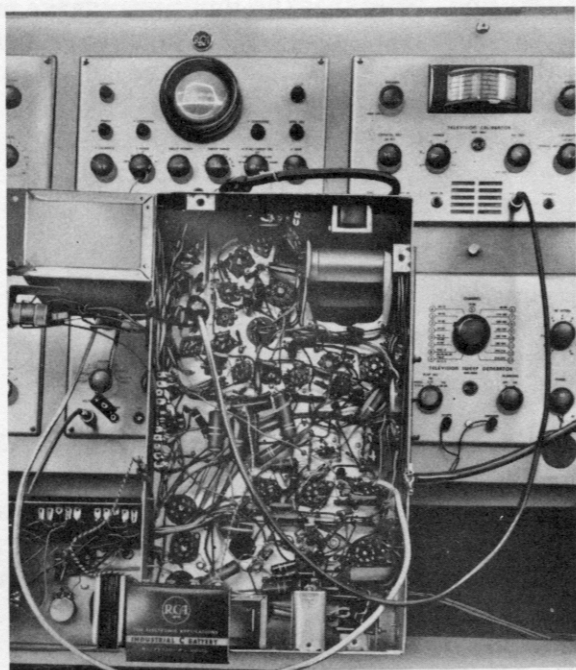

Fig. 207. Visual alignment setup of a TV receiver. Improper impedance matching between test equipment and receiver can cause changes in the observed scope pattern when you touch the signal-generator cable.

used to obtain sufficient input voltage. The output from the generator should have the same frequency as the channel to which the TV receiver is tuned. Touch the probe successively to the grid terminals of the first, second, third and fourth i.f. tubes, watching the pattern on the scope screen. (The probe can be touched to the plate terminals of the tube if desired.) If the pattern disappears at any point, the stage is dead and trouble shooting is in order.

In the illustration (Fig. 208) a poor connection to the plate-load resistor is indicated at x. In such case, a sine-wave pattern (modulation envelope) would appear on the scope screen when the resistor is prodded to make a good connection, but the sine-wave pattern will not be seen until the resistor is moved physically. If

*This occurs very seldom since at least 20,000 microvolts of signal are required for checking the first i.f. stage.

the probe is applied at the grid of such a stage, the sine-wave pattern will be visible continuously, showing that the circuit is normal on the grid side. Note that the input impedance to a crystal probe becomes lower as the operating frequency is increased.

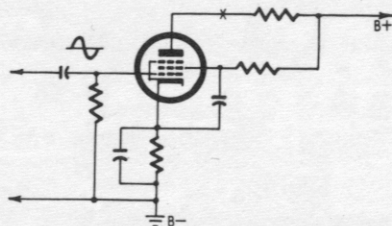

Fig. 208. A break at point x in the circuit (poor connection, intermittent resistor, etc.) can easily be found with the help of a scope.

Accordingly, the circuit loading will be greater at 45 than at 25 mc.

Fig. 209 shows the pattern obtained on the scope screen when the i.f. stage under test is dead. A normally operating stage will usually show a gain of approximately 10, as illustrated in Fig. 210.

Viewing response of single i.f. stage

The probe can be used to view the response curve of a single stage in a TV receiver or the combined response of two or more

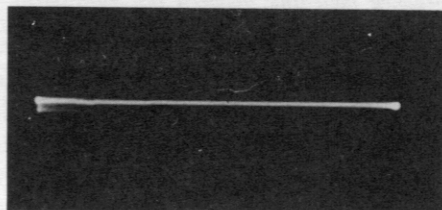

Fig. 209. Signal tracing with crystal probe shows dead stage as a horizontal line.

stages. In this application the circuit diagram for the receiver is first inspected to determine the particular coils which shall be tested. If a single coil is to be checked, apply the output from the sweep generator to the control grid of the tube preceding the coil. Inject the sweep signal through a 0.001- μ f blocking capacitor to avoid disturbing the grid bias of the tube. The crystal probe is then touched to the grid terminal of the tube following the coil, and the single-stage response curve appears on the scope screen.

You should note that this test tends to detune the coil, since the crystal probe has a definite amount of input capacitance even though such capacitance may be very small. To avoid this detuning, the probe can be applied to the *plate* terminal of the tube following the coil (as shown in Fig. 211), *provided* a 200-ohm resistor is shunted across the plate-load impedance during this test. The 200-ohm resistor "swamps out" the resonant response

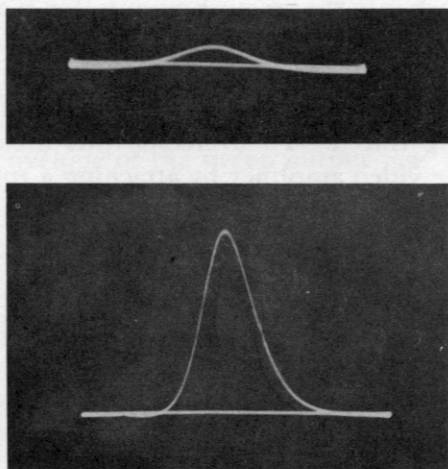

Fig. 210. When using a crystal probe to trace a sweep signal through the i.f. amplifier, the pattern height increases from stage to stage, as shown above. The example shown indicates a gain of 10 which is typical for a conventional receiver.

of the plate load so that the scope shows the true response curve of the grid circuit. At the same time the tube following the coil isolates the probe input capacitance from the coil under test so that no detuning occurs.

The tuned-grid circuit which is connected to the grid of the first tube does not affect the response because the low impedance of the sweep-generator cable acts as a swamping resistor. The crystal probe is a necessary part of the test setup because the scope will not respond directly to the high-frequency output of the sweep generator.

Tracing buzz pulse in sound i.f. strip

The crystal probe also has great utility in tracing a 60-cycle buzz pulse through the high-frequency circuits of an intercarrier receiver. The scope can be applied directly in audio-amplifier

circuits, when tracing a buzz pulse in the region between the output of the FM detector and the speaker. However, a scope will not respond directly to the 4.5-mc carrier frequency present in the circuits between the control grid of the picture tube and the input of the FM detector. Here the crystal probe permits the buzz pulse to be traced back to the grid of the picture tube.

Quite frequently you will find that the buzz pulse must be traced farther back into the receiver circuits, for example, into one of the video stages or even into one of the earlier stages. In such case, the crystal probe cannot be used directly, because the picture signal is much stronger than the sound signal and will mask the buzz pulse being traced. To overcome this difficulty, you can make tests in the video amplifier by attaching a tuned coil to the terminals of the crystal probe. This tuned coil is resonated at 4.5

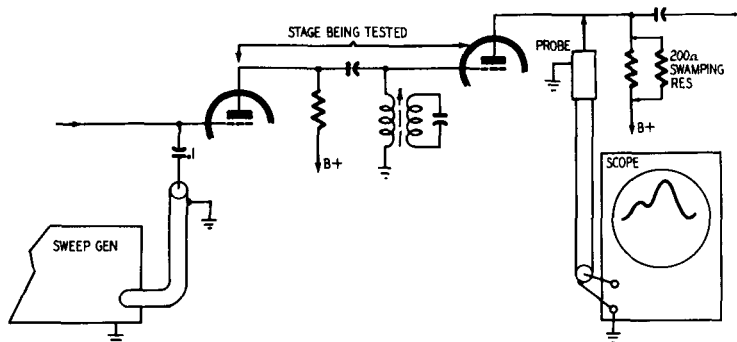

Fig. 211. Circuit diagram shows the use of a 200-ohm swamping resistor shunted across the plate load.

mc and is used by coupling the tuned coil loosely to any of the peaking coils in the video-amplifier circuit. If tests are to be made in the picture i.f. amplifier, a tuned coil is attached to the terminals of the probe and resonated to the second i.f. of the TV set.

In some cases the coil can be coupled closely to an i.f. coil; but if the receiver utilizes shielded coils or if the signal level is too low for satisfactory scope deflection, you should use a 3- μ f coupling capacitor to increase the coupling. The crystal probe will load the tuned coil. If the tuning is too broad and does not reject the picture signal satisfactorily, the crystal probe should be tapped down on the coil, as required, to minimize the loading.

When making a test for buzz using the crystal demodulator probe, the 4.5-mc sound signal on the scope screen will show a 60-cycle pulse if the buzz is affected by the setting of the fine tun-

ing control. This pulse will look somewhat like the 60-cycle vertical-sync pulses. If the buzz cannot be tuned, it will show up on the scope screen as a sharply pointed 60-cycle spike voltage.

Testing video amplifiers

There are two general methods of testing a video amplifier. One technique is to apply a sweep signal to the input of the amplifier and to display the amplifier output on the scope screen. The video sweep signal used in such tests varies from a low frequency of about 100 kc to 5 or 6 mc, 60 times a second.

The probe used must rectify video sweep frequencies from 100 kc to 5 or 6 mc and pass the envelope frequencies of the sweep output. The envelope of the sweep output may be considered as

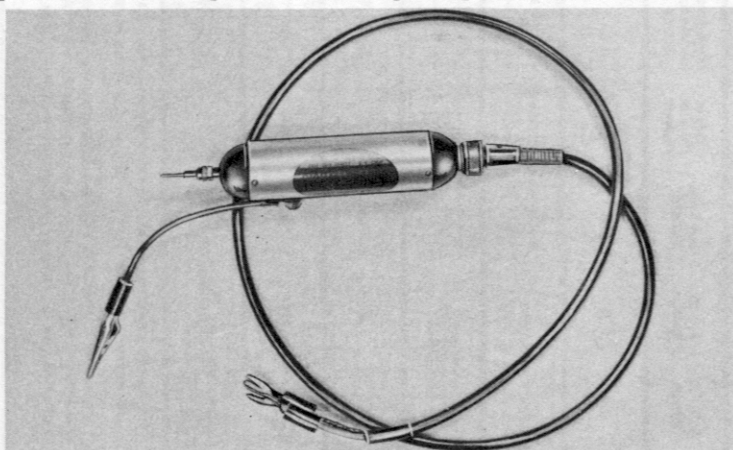

Fig. 212. Photo of a crystal probe. The ground lead is fastened to one side of the probe housing.

a 60-cycle square wave. In other words, the probe must demodulate the carrier component of the modulated wave (sweep output), and must develop the 60-cycle square-wave modulation envelope on the scope screen without appreciable distortion. A typical demodulator probe suitable for this application is shown in Fig. 212.

The crystal diode type used for video-sweep demodulation may be a matter of concern, as relatively high peak voltages may be encountered during video-amplifier testing. The normal output from a video amplifier is approximately 50 volts peak-to-peak. But when the amplifier is overdriven, as it frequently is, 75 to 100 volts peak-to-peak can be developed. In such a case, crystal diodes of the less rugged type will become damaged. However, there are several types that are quite durable. Voltage and current ratings

TYPE	1N34	1N35*	1N38	1N39	1N40**	1N41**	1N42**	1N54	1N55	1N56	1N57	1N59
Description	General Purpose Diode	Matched Duo-Diode	100-Volt Diode	200-Volt Diode	Plug-In Varistor	Lug-Type Varistor	Plug-In 100-Volt Varistor	High Back Resistance Diode	150-Volt Diode	High Conduction Diode	80-Volt Diode	100-Volt Diode
Continuous reverse working voltage (volts max.)	60	50	100	200	25	25	50	35	150	40	80	100
Forward current at +1 volt (ma min.)	5.0	7.5	3.0	3.0	12.75 (@ 1.5 volts)	12.75 (@ 1.5 volts)	12.75 (@ 1.5 volts)	5.0	3.0	15.0	4.0	4.0
Average anode current (ma max.)	40.	22.5	40.	40.	22.5	22.5	22.5	40.	40.	50.	40.	40.
Recurrent peak anode current (ma max.)	150	60	150	150	60	60	60	150	150	200	150	150
Instantaneous surge current (ma max., 1 sec.)	500	100	500	500	100	100	100	500	500	1000	500	500
Reverse current (μ a max.)	50@-10v 800@-50v	10 @ -10v	6 @ -3v 100 volts 300 @ -100v	200 @ -100 volts 300 @ -800 volts	50 @ -10v	50 @ -10v	6 @ -3v 675 @ -100 volts	10 @ -10v	300 @ -100 volts 800 @ -150 volts	300 @ -30v	500 @ -75v	800 @ -100 volts
Shunt capacitance (μ mf.)	1 μ mf. nominal for all types											
Ambient temperature range (°C)	-50° to +70° for all types											
Average life (hours)	More than 10,000 hours for all types											

*Units are matched in the forward direction at +1 volt so that the current flowing through the higher resistance unit is within 10% of that in the lower resistance unit. Ratings shown for each diode.

**Consist of 4 specially selected and matched germanium diodes whose resistances are balanced within $\pm 2.5\%$ in the forward direction at 1.5 volts. For additional balance, the forward resistances of each pair of varistor crystals are matched within 3 ohms. Ratings shown for each diode.

—Courtesy Sylvania Electric

Table 3—VOLTAGE AND CURRENT RATINGS FOR CRYSTAL DIODES USED IN TYPICAL OSCILLOSCOPE PROBES.

for crystal diodes used in typical crystal demodulator probes are shown in Table 3.

The crystal diode in the probe must be able to withstand double the applied peak voltage of the signal. Of course, this is true only of symmetrical wave forms, such as sine and square waves. For nonsinusoidal signal voltages, the crystal diode may have to withstand nearly double the peak voltage, more or less.

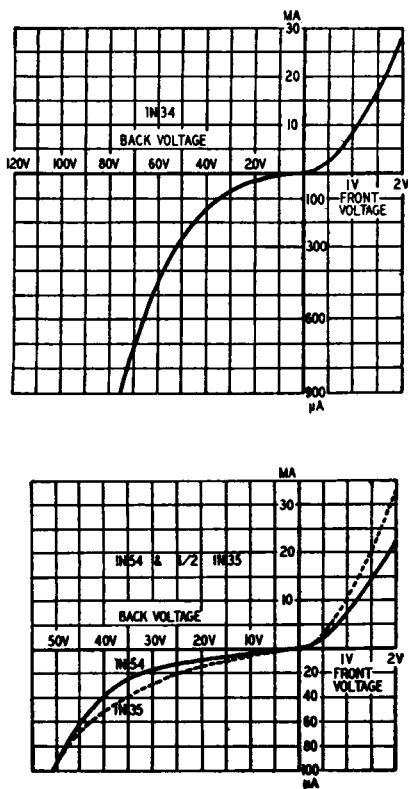

Fig. 213. Voltage-current relationships of three germanium crystal diodes.

The manner in which these considerations tie in with commercially available crystal diodes is shown in Table 3. The continuous reverse working voltage is not applied to the crystal in normal testing, but the peak back voltage may be taken as the peak-to-peak output voltage from the video amplifier when the crystal diode is used in a standard crystal probe. Most of the types in Table 3 may be used without extra precautions, although there

are a few that could be damaged by the high temporary transients which are often found when connecting the equipment. Crystal diodes used with video detectors have become damaged by high peak surges caused by sweep leads being dressed too closely to the detector leads. Fig. 213 shows that the back current of the crystal diode increases at a rapid rate in the region of maximum back voltage.

A demodulator probe which is satisfactory for i.f. signal tracing may be quite useless for video-amplifier testing. The reason is that the response of the video amplifier depends in great part on the shunt capacitance across the output. If this shunt capacitance is greater than the input capacitance of the picture tube, the high-frequency response will appear to be very poor. On the other hand, if the shunt capacitance of the test circuit is less than the input capacitance of the picture tube, the frequency response will appear to be better than it really is.

Obviously, the input impedance of the demodulator probe must equal the picture-tube input impedance. The probe must also have good response to 60-cycle square waves, because the demodulated sweep output is of the same general form as a 60-cycle square wave and, if the time constant of the probe is too long, the scope will indicate a true rise but a false fall of the response curve.

Adjusting a video amplifier

To view the video response curve on the screen of the scope, disconnect the picture tube from its socket and insert the prod of the crystal probe into the video-input terminal of the socket. (See Fig. 214.) Switch the receiver to a vacant channel to avoid interference. Apply a sweep signal from the sweep generator to the input of the video detector through a 10- μ f capacitor. The center frequency of the sweep generator output should be the same as the center frequency of the i.f. strip and the sweep-width control of the sweep generator should be set to approximately 6 mc. Apply an unmodulated r.f. signal from a marker generator in parallel with the sweep signal through a 10- μ f capacitor. The two 10- μ f capacitors help keep the video amplifier from being overloaded and also block any d.c. voltage which may be present. This method tests the detector peaking coils with the rest of the video-amplifier circuit and is preferable to applying a video-frequency sweep signal directly to the input of the video amplifier.

Tune the marker generator to the center frequency minus 3

mc of the sweep generator. This will now provide a beat signal which is developed in the output of the picture detector. The video response curve will now be visible on the scope screen. Adjust the output levels of the generators to a point which avoids overload and artificial flattening of the top of the video response curve. To inject a marker into the system for location of the essential points (such as 100 kc; 1, 2, 3 and 4 mc; and 4.5 mc) connect the output of a signal generator to a floating tube shield placed over the first video tube. Capacitors, resistors and peaking coils

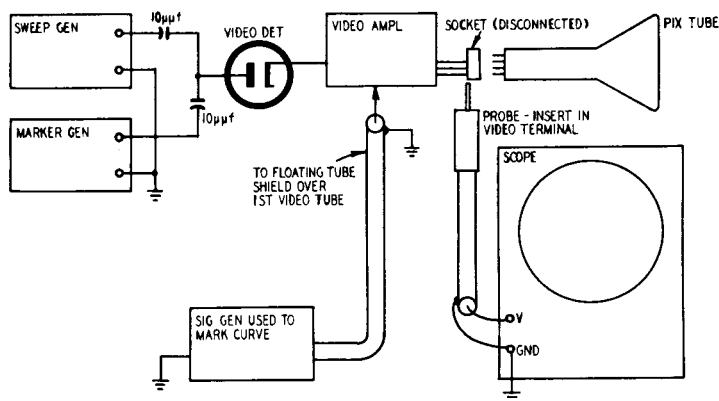

Fig. 214. Technique used for observing the response of a video amplifier on a scope.

are then adjusted to make the video response curve correspond with the published curve shown in the service notes for the receiver.

Square-wave testing

A second technique of video-amplifier testing is the square-wave test. It is informative because it shows up phase distortion as well as frequency distortion in the video amplifier.

Phase distortion is just another way of expressing abnormal time delay. This means that small picture elements may arrive slightly later or slightly earlier than large picture elements, regardless of their positions in the original picture. Accordingly, phase distortion causes the small picture elements to be displaced horizontally with respect to the larger elements. An observer would describe the picture as "smeary."

For accurate square-wave tests on video amplifiers, the vertical-deflection amplifier in the scope must have better frequency and

phase characteristics than the TV receiver. Otherwise the output from the video amplifier must be applied directly to the vertical-deflection plates of the scope. (This gives the best possible frequency and phase response from the scope but has the disadvantage of providing only $\frac{3}{8}$ - to $\frac{5}{8}$ -inch deflection on the scope screen.)

Never feed the output of the video amplifier directly through a cable to the input of the scope. Any usable length of cable will have very much greater capacitance than the grid-cathode circuit of the picture tube, and the square-wave response on the scope screen will be grossly misleading.

If such distortion is to be avoided, a low-capacitance probe must be used. This probe should have the same input capacitance as the picture tube

If the output of the video amplifier is applied directly to the deflection plates of the scope, the connection must be made with a short, *unshielded* test lead. Of course, the socket is removed from the base of the picture tube in all such tests, because the input capacitance of the scope setup is substituting for the input capacitance of the picture tube.

You will note in this discussion of square-wave testing of video amplifiers that we have not mentioned the frequencies at which the square-wave generator should be set.

There are different opinions as to the relationship between the frequency of the square wave and the bandpass of the amplifier under test. Some engineers maintain that when an amplifier passes a square wave without distortion, it is flat from $f/10$ to $10f$, where f is the square-wave frequency. Others work between 3-db (cutoff) points. To check low-frequency response, they set the generator to 10 times the amplifier response at 3 db and watch for an undistorted wave on the scope. For the high-frequency check, they set the generator to a frequency whose 21st harmonic is the same as the amplifier response at the high-frequency cutoff point. In any case, it takes practice and familiarity with one's scope and generator to get the best results from a square-wave test.

A video amplifier is designed for a given bandwidth with predetermined input and output impedances and known values of stray-wiring and shunt capacitances. When any test instrument is connected directly across the input or output of a video amplifier, it will upset the normal operating conditions and cause misleading observations. Long test leads to the scope and generator will in-

crease the stray capacitance of the circuit. The amplifier must work from and into the proper load impedances.

In TV broadcasting, special buffer amplifiers, probes, and other adapters are used with the scope and generator to prevent disturbing the inherent response characteristics of the circuit under test. You will not be able to rely on any square-wave response measurements that you make unless you can be sure that the frequency-determining constants of the circuit have not been altered by connections to the test instruments.

Marking a ratio-detector curve

The AM rejection of many ratio detectors is so complete in many receivers that a 4.5-mc beat marker cannot be seen on an

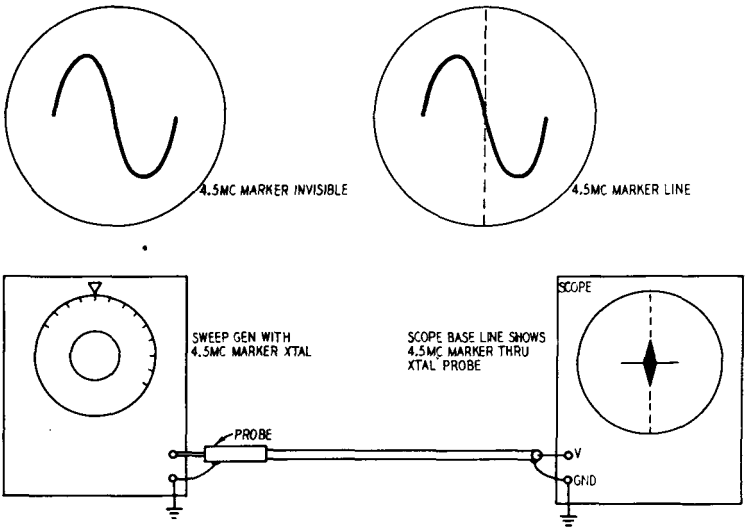

Fig. 215. Setup used for marking a ratio-detector or discriminator transformer curve.

S-curve or on a crossover curve. (A beat marker is an AM disturbance on the visual response curve.) To locate the marker, first disconnect the receiver and connect the probe from the sweep generator to the scope, as shown in Fig. 215. The crystal probe now substitutes temporarily for the 4.5-mc sound section of the TV receiver, and the 4.5-mc marker will be plainly visible along the horizontal base line of the scope screen.

Rotate the dial of the sweep generator until the 4.5-mc marker appears exactly in the center of the screen. From this point on, the vertical center line of the screen will continue to indicate the

4.5-mc point on the S-curve as long as the sweep-generator tuning control and the horizontal-centering control of the scope are untouched.

Disconnect the crystal probe and reconnect the TV receiver. Although the 4.5-mc marker will not be visible on the S-curve, this 4.5-mc point is now known and is marked by the intersection of the vertical center line of the scope screen with the S-curve. Some confusion may arise in case the retrace is not blanked; *if the retrace is not blanked, the phasing control of the sweep system should be adjusted to make the trace and retrace superimpose on each other, before work is started. If the retrace is blanked, no confusion will arise in any case.*

When it is desired to mark a crossover S-curve in this manner, proceed as follows: First obtain the crossover pattern, setting the sync controls as required on the scope panel. Next, disconnect the TV receiver and temporarily substitute the crystal probe; two markers will now be seen on the scope base line and the sweep generator is now tuned to make the two markers coincide with each other. The horizontal-centering control of the scope is then adjusted to make the 4.5-mc superimposed marker appear in the exact center of the scope screen. Finally, the crystal probe is removed and the TV receiver reconnected to the sweep generator and scope. The crossover point of the crossover pattern will, in general, appear to one side or the other of center screen. The ratio detector (or discriminator transformer) is adjusted to make the crossover point appear in the exact center of the scope screen and the detector is then in proper adjustment.

Calibrating a marker generator

When starting on an alignment job the first step is to check the calibration of the marker generator. Experienced technicians know that unless the 4.5-mc marking frequency is accurate, the sound output from the receiver will be weak and distorted, or perhaps completely inaudible. For this reason a method of calibrating the marker generator is an absolute necessity.

Without marker accuracy, the local-oscillator, ratio-detector and sound trap adjustments present a hopeless problem in the busy shop. Many marker generators have built-in calibrating facilities. Indication of zero-beat points—by beating the output from the marker generator with the harmonics from a quartz crystal—may be either audible or visual. If a generator does not have built-in

calibrating facilities, the technician should obtain a 1-, 2- or 5-mc crystal oscillator. It would be advantageous to use a voltage-doubler probe (no polarization). Voltage-doubler probes are described in the next chapter.

A crystal probe used in combination with a 1- or 2-mc crystal oscillator, as shown in Fig. 216, provides a very convenient method of calibrating a marker generator. The outputs of the marker generator and the crystal oscillator are connected in parallel with each other and the beating output is then applied to the scope

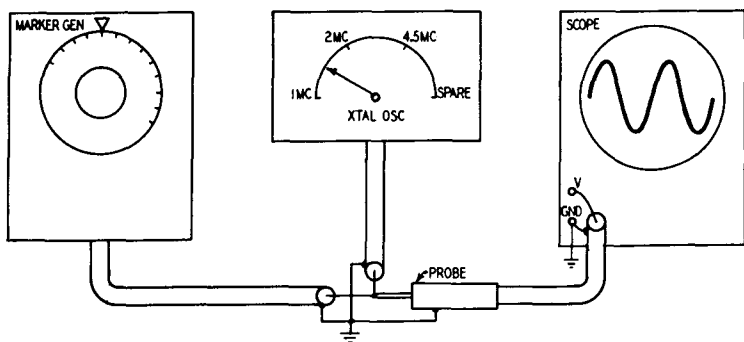

Fig. 216. A crystal demodulator probe can be used with a crystal oscillator for accurate calibration of a marker generator.

through the crystal probe. As the marker dial is rotated, strong beats will appear at each 1-mc (or 2-mc) point along the marker dial. It is most convenient to use a low-frequency sweep such as 60 c.p.s.; the individual beat cycles can then be seen as the zero-beat point is approached. The dial of the marker generator is adjusted as closely to zero beat as possible (minimum number of cycles visible on scope screen). If the marker generator is in calibration, the dial will then indicate an integral multiple of 1-mc (or 2-mc), such as 20, 22, 24, 26, 27, 33, 49 or more mc. The marker dial will develop zero beats (or a minimum number of sine-wave cycles on the scope screen) when the marker frequency is an exact multiple of the crystal fundamental frequency.

It is important to note that most marker generators have a strong harmonic output. Consequently, beats occur not only between the fundamental frequency of the marker generator and the crystal harmonics, but also between the harmonics of the marker generator and the crystal harmonics. Minor (interharmonic) beats will be therefore observed as well as major (fundamental vs. harmonic) beats.

To illustrate this fact with a practical example, consider an arrangement in which a marker generator is being beat against a 2-mc crystal. Strong beats will be observed on the scope screen at 20, 22, 24, 26 and 28 mc; however, weaker beats will also be observed at 21, 23, 25 and 27 mc. These interharmonic beats, accordingly, provide double the number of check points from a crystal compared with the number available from a generator having pure sine-wave output. Any crystal oscillator can be used, but service technicians will find it most useful to utilize 1-, 2- and 4.5-mc crystals.

If the harmonics of the crystal oscillator become too weak to check the higher frequencies of the generator, the technician must

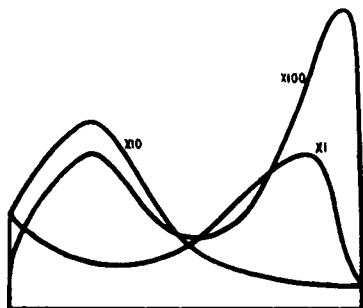

Fig. 217. Example of attenuator resonances and partial rectification of r.f. signal by the vertical amplifier of a scope.

obtain another signal generator. First, he calibrates the auxiliary generator from the crystal at as high a frequency as possible. Next, he substitutes the calibrated generator for the crystal oscillator. Thus, the auxiliary generator acts as a "stepping stone" to higher frequencies.

Setting the marker-generator dial to various frequencies may require a vernier scale, which can be used to split up the coarser divisions on the dial scale into very fine divisions.

Checking the output of a sweep generator

The output from the sweep generator is applied to the vertical-input terminals of a scope through the crystal probe. The generator is adjusted to develop a zero-volt base line instead of the return trace. (Not all sweep generators provide this facility.) If the output of the sweep generator is flat, two parallel lines will then be seen on the scope screen. If the generator is not flat, one

of the lines (base line) will be straight but the other (output level) will display dips and humps. The percentage of departure from flatness is then found by counting squares on the scope screen.

(*Note:* Many sweep generators used in service work have appreciable harmonic output at u.h.f. In such cases, the probe will go into resonance and the test will not be meaningful unless a low-pass filter is connected between the sweep generator output and the crystal probe. The low-pass filter should cut off above 200 mc—preferably above 100 mc—since lead lengths are extremely critical above 100 mc.)

Keep r.f. out of scope input

Because of unsuitable probes or improper modes of testing, the

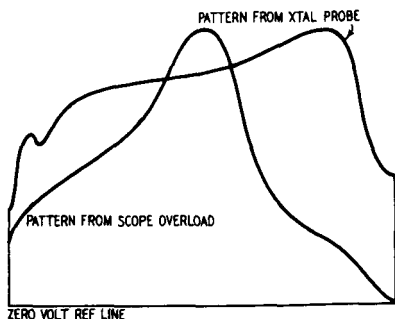

Fig. 218. Patterns obtained from crystal probe and from overloaded scope.

technician is sometimes misled during signal-tracing procedures by r.f. voltages entering the scope-input circuit. Only demodulated voltages from the probe should be permitted to enter the vertical amplifier of the scope. As shown in Fig. 217, frequency discrimination at r.f. and spurious resonances lead to erratic and unpredictable screen patterns. Partial rectification of the high-frequency voltages which find their way into the vertical amplifier develops a pattern which has no practical value.

When sweep-wave envelopes of i.f. signals on the scope screen are viewed by overloading the vertical amplifier with the signal under test, the pattern is highly distorted as compared with the pattern obtained when a suitable crystal probe is used, as illustrated in Fig. 218.

Ground returns

Brief mention was made in Chapter 1 of the necessity for a good ground connection for the probe. Unnecessary trouble is sometimes encountered in i.f. signal tracing because of failure to provide a good r.f. ground.

Suitable ground returns are of great importance in signal-tracing work. Much of the difficulty experienced by beginners comes from faulty grounding. Fig. 219 clearly distinguishes between the r.f. and the a.f. circuits which are present in the probe arrangement. *The ground lead to the chassis should always be kept very short, and the ground point should be made as near as possible to the signal take-off point in the i.f. amplifier circuit.*

This is of concern when high-frequency tests are being made. It is often necessary to dispense with the short ground lead that is provided with the probe and to make the ground return directly to the shielded case of the probe. Some commercial probes come equipped with an alligator clip fastened near the tip end directly to the metal probe housing.

While a long grounding route would not be of practical concern when a 10-to-1 or a 100-to-1 probe (described in Chapters 5 and 6) is in use, the long ground route commonly leads to curve distortion, regeneration or even oscillation when utilized with a crystal probe in i.f. amplifier signal tracing.

The probe should have a short ground lead which must be used at all times. Never make the mistake of using some other and longer ground lead, as absurd indications will frequently result. When testing an i.f. amplifier in particular, the ground return should be made to the same point in the set as the grid return. *Remember that the results obtained with the probe at frequencies above 100 mc will depend more upon the nature of the connections than upon any other single factor.*

Waveform errors

The output from many signal generators is far from sinusoidal. Likewise, the waveforms tested in the i.f. amplifier of a TV receiver are frequently of a pulse type. Since a crystal probe is polarized and the positive and negative peak voltages of nonsinusoidal waves are often widely different, the probe may appear to be very sensitive under some circumstances and insensitive under other circumstances. To be of the greatest general utility the crystal diode probe should provide forward resistance (lowest

crystal resistance) for applied positive voltages. This arrangement makes the crystal diode less susceptible to damage from

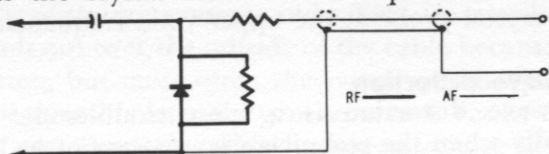

Fig. 219. Diagram of probe signal circuits.

surges when a.c. voltages are being tested in the presence of relatively high positive d.c. voltages.

Maximum signal voltage

A.c. voltages in excess of 20 peak volts will impair the sensitivity of the crystal diode, or burn it out completely.

Input impedance at high-channel frequencies

The input impedance of a crystal probe falls to very low values at upper frequencies. When the probe is to be used at frequen-

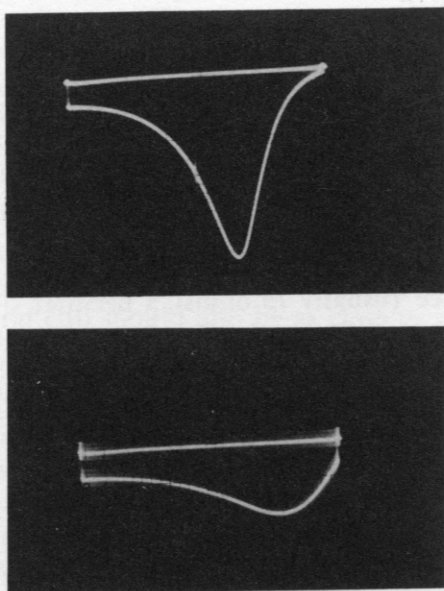

Fig. 220. Illustration at the top shows normal response curve. In the lower picture we see how the curve changes shape when sweep-generator tuning dial is touched.

cies in the vicinity of 200 mc, for example, it is essential to drive the probe from a very low impedance source — 50 ohms or less. It

may be noted that unbypassed cathode resistors and signal-generator output cables represent suitable low-impedance sources for operating a crystal probe at the upper v.h.f. frequencies.

Standing-wave distortion

Standing-wave distortion is a most troublesome alignment bug, especially when the technician is unaware of its basic cause. Standing-wave distortion shows up as a change in the shape of the response curve due to body capacitance in the vicinity of the instruments or the TV chassis, and appears as shown in Fig. 220.

There are at least two types of standing-wave distortion. One occurs *inside* the sweep-output cable, the other occurs *outside* the sweep-output cable. Standing waves are generated inside the sweep-output cable when the cable is improperly terminated. The sweep-output cable is usually connected to a light load, such as a floating tube shield over the mixer tube. This floating tube shield represents a very light capacitive load at the end of the sweep-output cable and does not provide the required termination (impedance match).

To terminate a sweep-output cable properly, it is usually necessary to shunt a 75-ohm carbon resistor across the end of the cable. The termination is sometimes provided by the manufacturer of the instrument. It is essential to use carbon resistors for termination, because a wirewound resistor will have high inductive reactance at intermediate alignment frequencies, and will fail to provide a proper termination.

When a sweep-output cable is not terminated in its own characteristic impedance (usually 75 ohms), a peculiar situation results. Not all of the electric energy flowing down the cable is absorbed by the load. Some of the downcoming energy is reflected back up the cable again. This reflected energy interferes with the incoming energy at half-wave points, and as the generator sweeps through the frequency band, these interferences, sometimes called "hot" spots and "cold" spots, oscillate along the cable, back and forth, at a 60-cycle rate. The generator will then deliver a higher voltage to the load at one frequency and a lower voltage at another.

The response curve is distorted by the abnormal voltages. But there is a distinguishing characteristic which is very important to the working technician—the curve shape changes when a terminating resistor is shunted across the end of the output cable, but the curve shape does not change when the technician moves about or touches the test instruments.

If the curve shape changes when a dial or cable is touched, standing-wave distortion is present as a result of sweep voltage on the outside of the instruments and cables. In some cases, sweep voltage spreads out over the outside of the cable because of improper termination, but more often the sweep voltage spreads along the outside of the cable from the generator end. Faulty connectors, for example, are often responsible for sweep voltage leaking from the generator to the outside of the cable.

One of the standard methods for minimizing trouble from standing-wave voltages of this type is to ground all the test instruments together. A business like way is to mount all the instruments in a rack-and-panel assembly, which can in turn be grounded to a water pipe. More often than not a water pipe will not be close at hand. In such an event use a heavy copper strap to connect all instrument cases and run the strap to a water pipe or a copper rod driven into the earth. Where possible, solder the copper strap to the instrument cases and, of course, to the grounded rod.

Connecting the crystal probe

Because of the crowded condition existing in some TV chassis the service technician is often inclined to put the tip of the probe at the nearest convenient point. This type of technique is suitable for measuring d.c. voltages with a v.t.v.m. and a pair of clip leads, but can lead to misleading results when a crystal probe is used. The probe point should be placed as closely as possible, preferably directly, at the exact spot where the signal voltage is to be checked. The probe ground clip should also be as close to the check point as possible.

Lead dress, particularly in high-frequency circuits, is important. In servicing, the natural tendency is to push leads out of the way so that you can get in at the test point underneath the wiring. High-frequency circuits, characterized by small values of inductance and capacitance, are sensitive to any changes in wiring or components. Try to put the probe point directly at the spot where you want to make your check, moving as few wires and components as possible.

Crystal facts

Diode crystals are marked in a number of ways. The letter K or the word "cath" sometimes appears on the crystal to indicate

the cathode. Some crystals use a band of color near the cathode end of the crystal.

Crystals are seriously affected by heat. A soldering iron can easily ruin a good crystal. If you find it necessary to solder to crystal diodes, hold the crystal diode lead with the flat portion of a pair of long-nose pliers. The pliers should be held as close to the body of the crystal as possible.

Sometimes you will find it necessary to fasten a crystal probe into a circuit and to have the probe remain in place for a period of time. Don't support the probe on any heat-generating device. Instead, let the probe clip on device hold the unit in place.

Single diode crystal units do not supply any signal gain but produce a signal loss instead. For many applications, such as those described in this chapter, this is not serious. However, for work in low-level stages, a crystal type voltage-doubler probe is often helpful. Such probes are described in the next chapter.

voltage-doubler probes

A voltage-doubler probe has considerable utility in television trouble-shooting procedures because it makes possible double the amount of deflection on a scope screen that can be obtained from a half-wave probe (assuming a symmetrical waveform input such as a sine wave or square wave). Hence, it is useful in signal tracing low-level stages. On the other hand, a voltage-doubling probe has considerably lower input impedance than a half-wave probe and its application is accordingly limited to

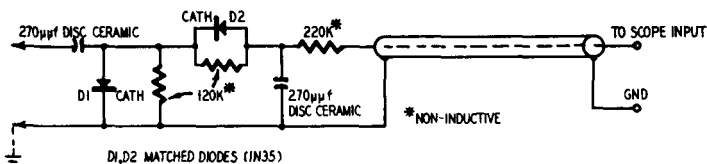

Fig. 301. Circuit diagram of voltage-doubler demodulator probe. This probe uses a pair of matched crystal diodes.

medium- and low-impedance circuit testing. The voltage-doubling probe also has less frequency response than a half-wave probe and should not be used in circuits carrying frequencies higher than standard intermediate frequencies in TV receivers.

When used out of its response stage, the voltage-doubler probe network goes into complex resonances which cause severe variations in the output voltage from the probe. At some frequencies the output may be practically zero while at other frequencies the output may be several times the voltage of the input. Conse-

quently, the response of such a probe is unpredictable when used outside of its rated frequency range. The maximum allowable input voltage for a voltage-doubler probe is approximately the same as for the usual single crystal probe.

A typical voltage-doubler demodulator probe is shown in Fig. 301. While designed for work with a scope, it can also be used with a v.t.v.m. In operation, the carrier component of the modulated wave is rectified and filtered to a d.c. voltage, while the envelope which represents the modulating signal is passed by the probe network into the vertical amplifier of the scope.

Some of the techniques used with the voltage-doubler probe are the same as those described in the preceding chapter. For example, if you want to calibrate a marker generator, mark a ratio-detector S-curve, etc., refer to Chapter 2 for full details.

Input voltage limitation

A voltage-doubler probe is also known as a peak-to-peak probe.

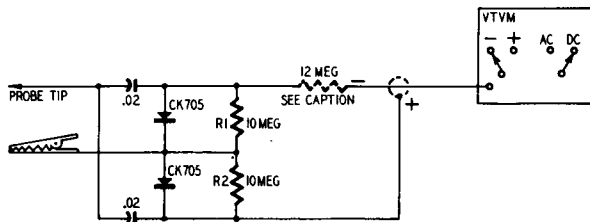

Fig. 302. Voltage-doubler probe designed for use with a v.t.v.m. The 12-megohm resistor is inserted when the probe is used with a v.t.v.m. having a 25-megohm input resistance. Use a jumper here if the v.t.v.m. has an 11-megohm input resistance.

Unlike the half-wave type of probe described in Chapters 1 and 2, the voltage-doubler probe can be used for the test and measurement of nonsymmetrical waveforms. In a TV set, these waveforms are found in the sync and sweep circuits. *It is dangerous to use a crystal type voltage-doubler probe in sync and sweep circuits, since such voltages are much higher than the maximum rating of the crystal and will undoubtedly burn it out.* It is true that there are a few test points where you can use the crystal voltage-doubler probe. For example, you can use it at the cathode of the sync separator tube or at the cathode of the horizontal control tube. These are low-voltage, low-impedance points. However, even with manufacturers' literature at hand giving you the expected amount of peak-to-peak voltage, it is always possible to put the probe tip on the wrong pin of a tube.

Crystal probes of the half-wave and voltage-doubler types will not be damaged by application of voltages from r.f., i.f. or 4.5-mc circuits. For scope work in sync and sweep circuits it is advisable to use a vacuum-tube type peak-to-peak probe. These probes are described in Chapter 10.

Peak-to-peak probe for v.t.v.m.

Voltage-doubler probes are designed for use with a particular test instrument, such as a scope or a v.t.v.m. The circuit diagram in Fig. 302 shows a commercial type probe designed for use with a v.t.v.m. This probe can be used for peak-to-peak voltage measurements of complex TV waveforms. The probe has an operating frequency range of 5 kc to 5 mc. The maximum input to the

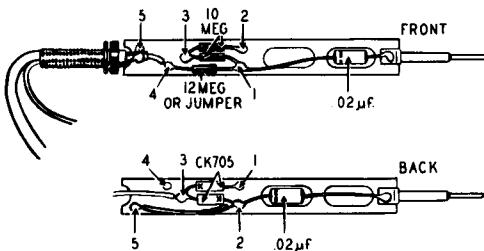

Fig. 303. Construction of a voltage-doubler probe. The parts are mounted on a terminal board. Front and back views are shown. The numbers, 1 to 5 inclusive, indicate connections made through brass soldering rivets.

probe is 80 volts peak-to-peak and/or 600 volts d.c. The output of the probe is negative d.c. volts equal to the peak-to-peak voltage of any waveform, complex or sine.

Since the output of the probe of Fig. 302 is *negative*, the v.t.v.m. should be set to read negative d.c. volts. You can then read peak-to-peak volts directly on the d.c. scales of the v.t.v.m. without the need for using any multiplying factor. Because of the nonlinearity of the crystal diodes, voltages below 5 volts peak-to-peak will give a lower-than-normal indication on the v.t.v.m.

If you will examine the circuit of Fig. 302 carefully, you will see that the shield braid of the output cable connects to one end of the crystal diode load resistor (bottom end of the 10-megohm resistor R2). The shield braid also connects to the negative (ground) side of your v.t.v.m. This means that, when using this probe, you should not ground your v.t.v.m., nor should you connect the ground lead of the v.t.v.m. to the chassis of the set being fixed as this will short one of the crystals and its load resistor.

The construction of the probe is shown in Fig. 303. The parts are mounted on a terminal board. The illustration shows how the components are placed on both sides of this board.

Calibration of marker generator

A voltage-doubler probe is very useful for calibrating a marker generator because the probe works out of a low-impedance source in this application. It will give double deflection on the scope screen as compared with the deflection obtained from a half-wave probe. Accordingly the operator can work farther out on the harmonics of a given crystal. Since the voltage of the harmonics is approximately inversely proportional to the order of the harmonic, the advantage of the doubler probe is that calibration can be carried out at twice as high a frequency as when a half-wave probe is used.

Marking ratio-detector S-curve

Like the half-wave crystal probe, the voltage-doubler probe will be found of great value in determination of the 4.5-mc point on an S-curve. The doubler probe has an advantage in this application. If the marker voltage is quite weak, the marker will appear double-height on the scope screen when the voltage-doubler probe is used.

I.f. signal tracing and sync-buzz tracing

A voltage-doubler probe can be used for i.f. signal and sync-buzz tracing. When used for signal tracing, the TV receiver is energized at the antenna terminals by a suitably modulated r.f. signal, a sweep-frequency signal or a TV station signal. To trace this signal through the signal circuits of the receiver, the voltage-doubler probe is applied progressively to the plate terminals of the mixer, first i.f., second i.f., third i.f. and fourth i.f. stages. It is preferable to test at the plate terminals of the i.f. tubes instead of testing at the control grid terminals, because the grid circuit often has a higher impedance than the plate circuit.

Circuit loading and resulting circuit disturbance are lessened when the voltage-doubler probe is applied at the plate terminal of an i.f. tube. The voltage-doubler probe can be applied directly in 4.5-mc sound circuits to determine the percentage of downward modulation produced by the 60-cycle buzz voltage; in this application a d.c. scope is required. The voltage-doubler probe

must be used with a suitably tuned head to check for sync-buzz generation in the i.f. or video amplifiers, as will be explained later.

Color TV testing

The circuit diagram of a typical commercial peak-to-peak high-frequency probe is shown in Fig. 304. Probes of this type can be used in making video-frequency sweep tests of the chroma band-pass amplifier and other video-frequency circuits in color television receivers. In such applications, place the probe across a suitable low-impedance point (such as the color-intensity control) to avoid circuit disturbance by the capacitive component of the probe input impedance. The input capacitance of the probe shown in Fig. 304 is 5 μf . This is sufficient to distort the response of the bandpass circuits if shunted across the filter inductors.

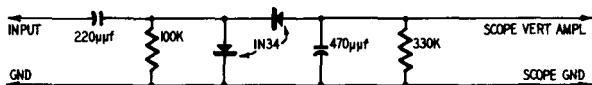

Fig. 304. Typical circuit of commercial peak-to-peak high-frequency probe.

Signal source used in signal tracing

The pattern observed on the scope during signal-tracing procedures depends upon the type of signal applied to the antenna terminals of the receiver. In any case, the scope can be swept at 60 cycles per second. When a TV station signal is used as a signal source, the operator sees the composite video signal on the scope screen. (A reasonably strong signal must be used in order to obtain satisfactory scope deflection when testing early i.f. stages, or a scope preamplifier must be used.)*

The relative height of the pattern from one i.f. stage to the next is a measure of the progressive gain of the receiver. When a sweep-frequency generator is used to energize the antenna terminals of the receiver, a frequency response curve will be observed on the scope screen. The bandwidth of the response curve is normally greatest at the first stage in the receiver and least at the last stage in the receiver (unless circuit trouble exists).

Dead-stage indication, regeneration and sync buzz

When a dead i.f. stage is encountered in the receiver, no deflec-

*See page 16, chapter 1.

tion is obtained on the scope screen. If the trouble is a weak stage, you will note a decrease, instead of an increase, in the height of the pattern. Regeneration in an i.f. stage causes an abnormal decrease in bandwidth and an abnormal increase in gain. The maximum normal gain of an i.f. stage (in the absence of regeneration) is approximately 15. Lesser gains are observed with appreciable grid bias on the i.f. amplifier tubes.

The voltage-doubler probe can also be used advantageously to check i.f. amplifier stages and video-amplifier stages for generation of 60-cycle sync buzz. To make a buzz check, a tuned head (parallel-resonant circuit) is tuned to the sound-carrier frequency and connected to the input terminals of the voltage-doubler probe. The tuned head is then coupled inductively to the i.f. coils or to the peaking coils of the receiver for test checks.

Peak-to-peak voltage measurements

The voltage-doubler probe responds to the peak-to-peak voltage of the signal under test, hence can be used to measure peak-to-peak voltage values in combination with a d.c. v.t.v.m. Before undertaking to make such peak-to-peak voltage measurements, you should check the scale indication of your v.t.v.m. against a known source of peak-to-peak voltage in order to determine the attenuation factor of the probe. Since the input resistances of various v.t.v.m.'s are different and since the front-to-back ratios of various crystal diodes are also different, the voltage-doubler probes must be individually calibrated for insertion loss.

The voltage-doubler probe eliminates the basic error commonly encountered when the operator attempts to make a peak-to-peak voltage measurement with a half-wave probe. A serious error usually arises in such cases because the half-wave probe must be "turned over" in making the required pair of measurements and very serious circuit loading results. Accordingly, a correct peak-to-peak voltage value is obtained when the voltage-doubler probe is used, but an incorrect peak-to-peak voltage value is obtained when the half-wave probe is used for such measurement.

Frequency response of probe

The frequency response of the voltage-doubler probe can be made essentially flat up to 150 mc; the probe is also useful for comparative measurements at still higher frequencies. The probe is therefore very useful in marker-generator or calibrating proced-

ures, combining high sensitivity with good frequency response. In general, when a half-wave probe does not provide ample deflection on the scope screen, the voltage-doubler probe should be utilized. Keep in mind, however, that a half-wave probe can provide additional flat frequency response up to 300 mc.

Sixty-cycle rejection of probe

Since the voltage-doubler probe utilizes shunt detectors in combination with relatively small series-charging capacitors, 60-cycle

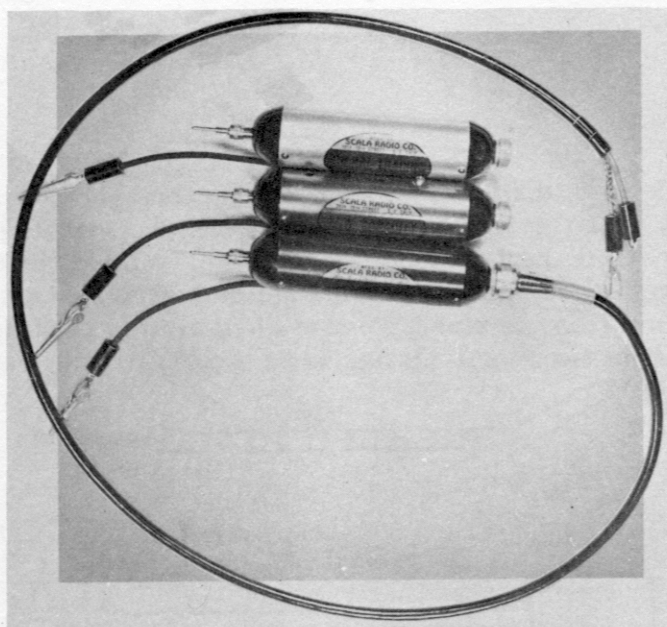

Fig. 305. Three types of scope probes used in TV test work. (Top) Crystal-demodulator signal-tracing probe; (center) low-capacitance high-impedance 10-1 voltage-divider probe; (bottom) 100-1 capacitance-divider high-voltage probe.

hum voltage is greatly attenuated with respect to r.f. or i.f. voltage. Hence, tests in heater circuits, a.g.c. lines and d.c. supply lines are greatly facilitated. The operator can check for "hot" bypass or decoupling capacitors, heater "hash" or video voltage in a.g.c. lines without encountering serious disturbance of the scope screen pattern from hum or heater voltage.

Commercial type probes used in television servicing (and also for radio repair) are relatively inexpensive and present a professional appearance. Whether you buy or build is simply a mat-

ter of personal choice. In Fig. 305 we have three different types of scope probes used in television test work. At the top is a crystal demodulator signal-tracing probe; at center, a low-capacitance high-impedance, 10-1 voltage-divider probe; at bottom, a 100-1 capacitance-divider high-voltage probe. The crystal demodulator signal-tracing probe has already been discussed. The other probes form the subject material for subsequent chapters.

Commercial types of peak-to-peak probes use either crystals or vacuum-tube diodes. You will find a description of tube type voltage-doubler probes in Chapter 10.

balanced probes

If the coupling between two electrical circuits is to be of maximum efficiency, the impedance of the source of power (generator) should be equal to the impedance of the load. In the case of a signal generator feeding the input to a TV receiver, therefore, the impedance of the signal generator should be equal to the impedance of the transmission line and the impedance of the line

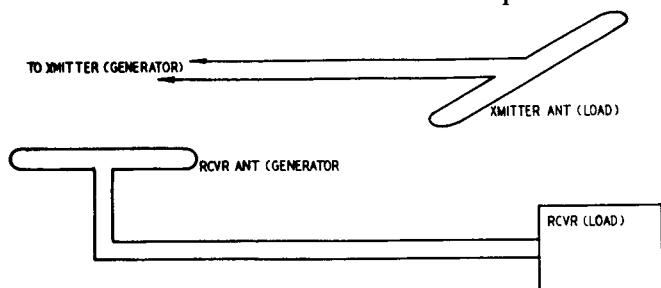

Fig. 401. *The energy supplying source is called the generator. The receiver of the energy is called the load.*

should be equal to the input impedance of the tuner in the TV receiver. The same rule applies, of course, if we are using an antenna instead of a signal generator to supply the energy to the front end of the TV receiver. (The source that supplies the power, whether it is a TV transmitter, a receiving antenna or a generator, is always considered the generator or source-of-supply end; the receiver or transmitting antenna is always expressed as the load end.) See Fig. 401.

If the two impedances are not equal, all the energy supplied by

the generator will not be absorbed by the load and some of it will be reflected back through the connecting line to the generator. In the meantime the generator is continually putting out energy,

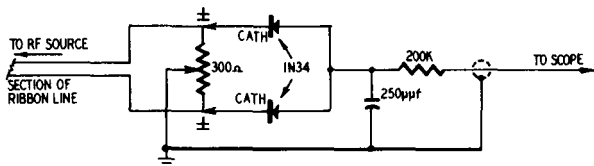

Fig. 402. Circuit diagram of a balanced probe. The circuit resembles a full-wave rectifier.

but, because of the time required for this energy to travel to the load and back to the generator, the energy just coming out of the

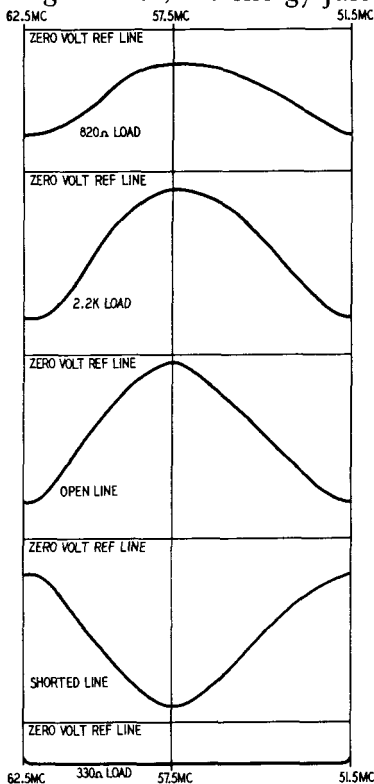

Fig. 403. The margin by which the standing wave pattern fails to contact the reference line measures the loss in the transmission line.

generator will be out of phase (time) with the energy that has already been reflected back from the load.

In television circuits, this is very undesirable because this reflected power will cancel some of the signal coming out of the antenna into the transmission line, making the signal weaker. As a matter of fact, if this unwanted reflected signal is strong enough, it may even attenuate the signal to a point where it is completely useless, especially in fringe areas where the signal is not too strong.

Need for balanced probe

To check mismatches in impedances, the balanced probe is invaluable. By following a simple procedure the technician can use the probe to determine whether the generator, line or load is

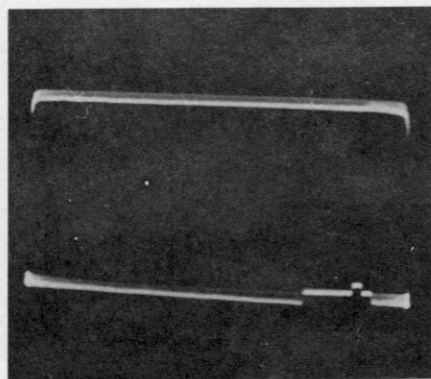

Fig. 404. The crystal probe may rectify the incoming video signal when the impedance match of the line is checked with high field strength present from a local TV station. In the example shown above, the video signal appears chiefly as a "stripped" vertical pulse in the impedance pattern.

at fault. Of course we have to assume, if the tests are to be accurate, that all of the instruments used have themselves a fairly high degree of accuracy. If they do not, we should know their error so that proper compensation can be made for arriving at the correct results.

A balanced crystal probe (or two single-ended conventional crystal probes) can be used to check a lead-in for flatness or impedance match. A generalized circuit of a balanced crystal probe is seen in Fig. 402. Typical patterns and the conditions responsible for the observed standing-wave ratios are shown in Fig. 403. To understand the operation of a double-ended probe, note that the two diodes do not conduct simultaneously. As far as the instantaneous lead-in voltages are concerned, when the input signal to one diode is positive, the input signal to the other is

negative. These polarities alternate at the carrier frequency and the diodes conduct alternately.

Standing-wave patterns are sometimes interfered with by TV station signals or 60-cycle hum voltage, as shown in Figs. 404 and 405. Unless the operator recognizes the sources of such distortion, he may be at a loss to interpret the pattern which he has obtained.

In Fig. 402, the scope and the sweep generator are located at opposite ends of the transmission line. That is, the sweep generator is located at the left-hand end of the lead, and the scope is connected (through the crystal probe) at the right-hand end. In

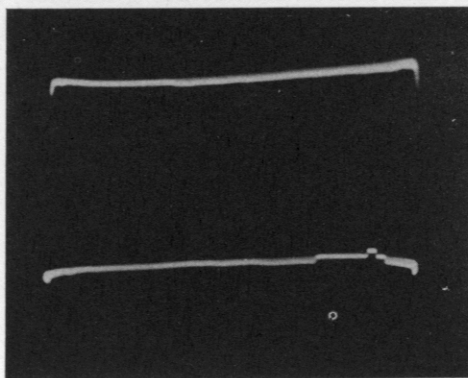

Fig. 405. Curvature in the zero-volt reference line, sometimes noted during impedance checks of lead-ins and antennas, or front ends of TV receivers, is caused by 60-cycle pickup in the balanced crystal probe. Grounds should all be returned to a common point, and thence to a cold-water pipe. Ground all instrument cases.

this test, a pair of 150-ohm resistors are connected in series to provide a 300-ohm load with a center tap. The center tap is required in this test to provide a d.c. return path for the balanced probe.

If the characteristic impedance of the line is 300 ohms, the 300-ohm load will cause a flat trace to appear on the scope screen, as shown at the top of the photograph in Fig. 404. If the characteristic impedance of the line is not 300 ohms, the 300-ohm load will cause the trace to depart from flatness. Fig. 403 shows the behavior of a section of 300-ohm ribbon line when swept with various values of load resistance. The operator will understand that a length of lead 25 or 30 feet long should be used in this test, so that appreciable standing waves can be developed at representative TV signal frequencies. Otherwise the scope must have very high gain to obtain satisfactory deflection.

Several other practical considerations must be observed. Since the scope and the sweep generator are located at opposite ends of the line which is being tested, there may be a problem of obtaining a horizontal-sweep voltage from the generator for the scope. Although some service scopes provide a phasable horizontal-sweep voltage which is built into the scope, many service scopes do not have this built-in sweep facility, but rely upon the phasable, horizontal-sweep voltage which is built into the sweep generator. In that case, test leads are run from the generator to the scope to provide such a voltage.

Since these test leads would have to be 25 or 30 feet long, other test setups may be found more convenient when using a scope

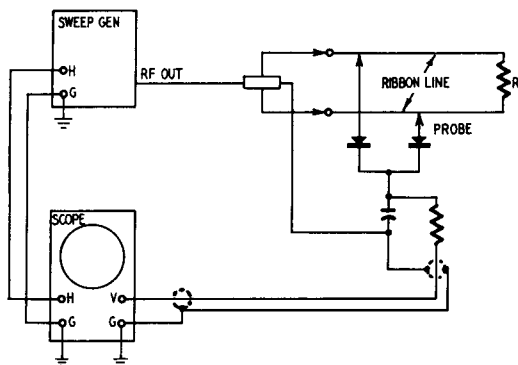

Fig. 406. Horizontal sweep leads shortened. Scope is at generator end of line.

without a built-in horizontal phasable sweep. The probe and scope can be connected at the generator end of the line, if desired, as shown in Fig. 406. In this case, the generator has an r.f. output cable which is terminated in a center-tapped load. This center point is connected to the ground system of the test setup, as shown; the load resistor R then does not need to be center-tapped, and the scope is conveniently swept from the generator, as indicated by the leads between them in Fig. 406. This arrangement can be applied conveniently, especially when the load R may represent a remote point such as an antenna whose match to the lead-in is to be tested.

Zero-volt reference line

These tests mean little unless a zero-volt reference line is available in the pattern. Since generators have unbalanced output, a resistive network is used to produce a balanced condition, as

shown in Fig. 407-a,b. The probe is connected to the balanced output of the signal generator. If the generator is working properly and its output is linear (constant throughout its sweeping range), a straight line will appear across the scope screen. This test would mean very little if a zero-volt reference line was not visible on the scope screen. This zero-volt reference line makes it possible to determine the ratio of maximum to minimum because the zero-volt reference line will appear as a straight line and the resultant

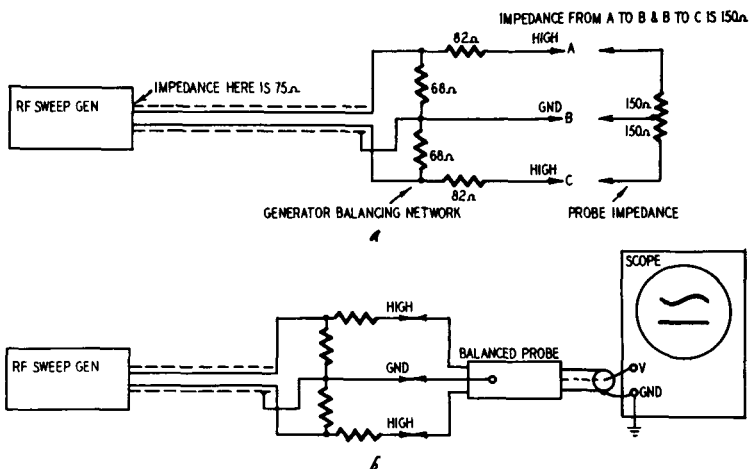

Fig. 407-a,b. The balanced probe has a 300 ohm input, 75 ohm output. Since sweep generators have a 75 ohm output, a generator balancing network is needed to match the generator to the probe. This is shown in a, above. The technique for connecting the scope, balanced probe, matching network, and sweep generator is shown in the lower illustration, b.

output of the sweep generator will appear as another line vertically displaced from the reference line on the screen (Fig. 408).

If the sweep generator used is provided with internal blanking (zero reference), the zero-volt reference line is immediately available when the blanking control on the sweep generator is turned to the blanking-on position. *Caution:* it is important to mention that if misleading curves on the scope screen are to be avoided, the phasing control on the sweep generator must be adjusted so the trace and retrace lines on the scope screen coincide before the blanking control is switched to the blanking-on position.

If the sweep generator does not have an internal blanking provision, a d.c. scope may be used to provide the zero-volt reference line. This is accomplished by positioning the scope trace with zero-signal input and marking this line with a grease pencil. This line may then be used as a zero-volt reference line, provided

that the positioning controls on the scope are not touched. It is important to have the d.c. amplifier balanced; otherwise the zero reference line may change with gain.

Obtaining the reference line

There are two ways of obtaining a zero-volt reference line. The most convenient one is to use a sweep generator in which

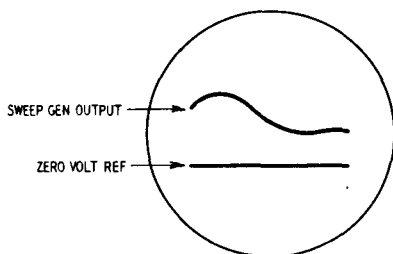

Fig. 408. Sweep generator output and zero volt reference line.

the return trace is converted automatically into a zero-volt reference. This is done by providing a built-in source of square-wave bias to the sweep oscillator in the generator. If the technician must use a sweep generator which does not provide a zero-volt reference line in the pattern, any arrangement which rapidly shorts and unshorts the vertical-input terminals of the scope will serve the same purpose, as shown in Fig. 409. The rate of vib-

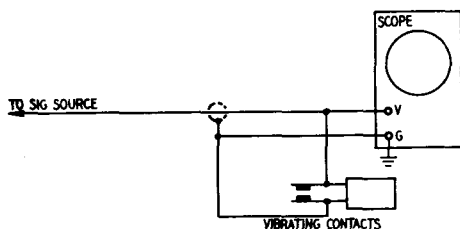

Fig. 409. Vibrating contacts intermittently short the vertical input of the scope.

ration should be considerably greater than 60 cycles, but may be any convenient arbitrary rate. The vibrating contacts operate to make the input signal fall to zero many times during the progress of the trace, thus making the zero-volt reference level apparent as a dashed line. The average constructor will usually have little trouble devising a vibrator, if one is needed. The vibrating frequency does not have to be stable, but the contacts

must be completely independent of the magnetic circuit of the vibrating element.

The generator characteristic may be linear or nonlinear. If the line on the scope screen representing the generator output is nonlinear (Fig. 408), we can assume that the generator output is not linear. For any measurement purpose, the degree of deviation from that shape will indicate the degree of mismatch in the tests.

In order to make use of this knowledge of the output characteristics of the sweep generator, the technician must trace this characteristic output curve on the scope screen in grease pencil (China marking crayon) and note its position relative to the zero-volt reference line. The technician must first determine this characteristic so he can apply a correction, if one is needed. To make the matter clearer, consider the case in which the length of line shown in Fig. 406 is reduced to zero. No effects of standing waves are then apparent in the pattern, because they are absent. The trace should then be reasonably flat.

Consider, however, the cases shown in Fig. 410, in which the generator characteristics are not entirely flat. Such instances can arise in practice, due to high harmonics in the generator output combined with probe resonances, for example. In other cases, the fundamental voltage from the generator may vary somewhat. In any case, a correction must be made.

Testing transmission lines

Now that the zero-volt reference line and the characteristics of the sweep generator have been established, the technician is prepared to put this setup through its paces. As discussed in previous paragraphs, the energy not absorbed by the load will be reflected to the generator. Further, because of the time lost traveling through the transmission line, it will be out of phase (time) with the signal just coming out of the generator. The result will be a disturbance of the wave shape and/or phase (time) of the signal at the generator terminal. The degree of disturbance will be determined by the amount of energy reflected from the load (degree of mismatch).

To check the impedance of a transmission line, connect the balanced probe, the sweep generator, the scope and the length of transmission line (20 to 30 feet) as shown in Fig. 411. Terminate the far end of the transmission line in a noninductive carbon resistor equal in resistance to the rated characteristic impedance

of the transmission line under test. This is ordinarily 300 ohms.
If the actual characteristic impedance of the transmission line

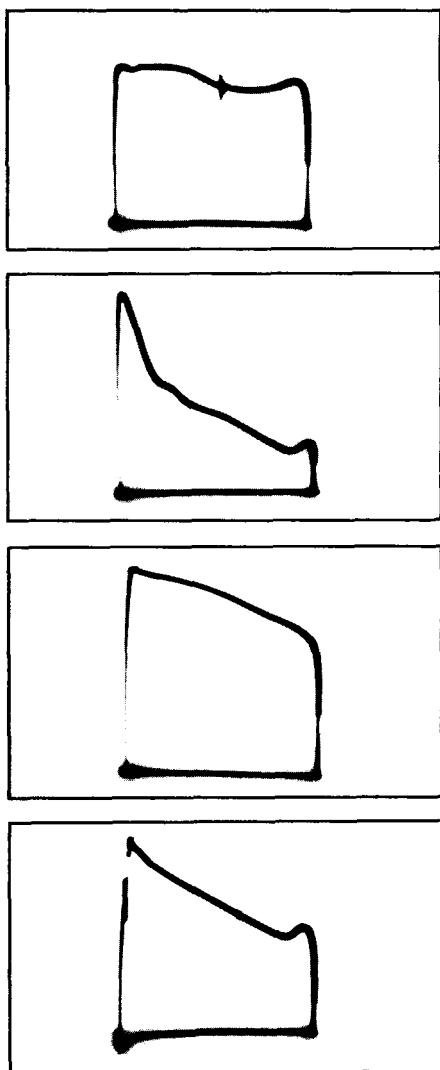

Fig. 410. When an unsuitable demodulator probe is used to test the output from a sweep-frequency oscillator, or when the instrument is operating incorrectly, or if test conditions are unsuitable, typical patterns such as these will be observed as the instrument is tuned through its range.

is equal to its rated value, the traces visible on the scope screen (with appropriate vertical-gain adjustments) will coincide with

the traces visible on the scope screen when the generator output characteristics are checked (Fig. 408). If the traces do not coincide, the actual impedance of the line is not equal to its rated impedance. When this condition occurs, the actual impedance of the line may be determined by substituting various values of

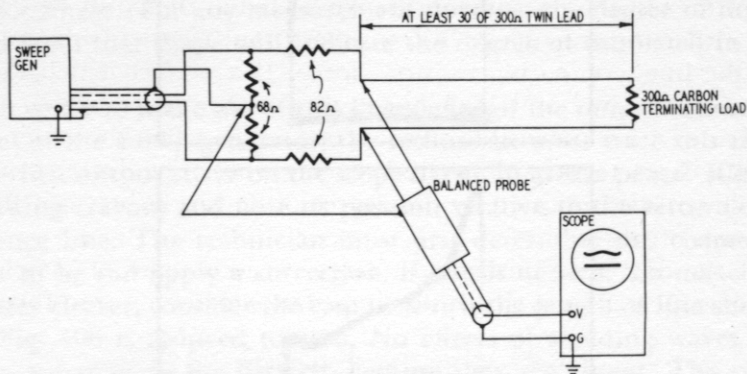

Fig. 411. Technique for testing impedance matching of transmission line. A resistive network is used to convert the sweep signal generator from unbalanced to balanced output.

noninductive carbon resistors as a termination for the line until the traces on the scope screen do coincide with those of the generator output characteristics. Under these latter conditions, the

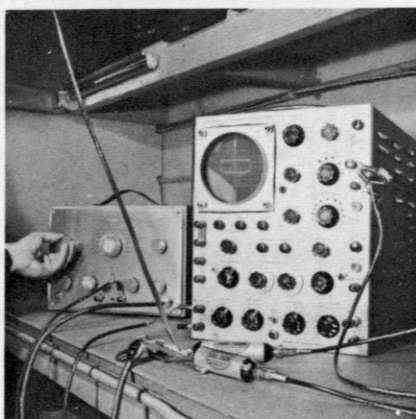

Fig. 412. Photo of test setup utilizing dual crystal probes instead of a balanced probe.

value of the terminating resistor will be the value of the actual characteristic impedance of the line in question.

Checking mismatch between transmission line and antenna or TV input

The setup outlined in the previous paragraph may be used to determine the amount of mismatch between a transmission line and either the antenna or TV receiver input circuit.

In this test the instruments are connected as shown in Fig. 411, and either the antenna or TV receiver input circuit is substituted for the line-terminating resistor (load). If a perfect match exists between the line and load, the traces on the scope screen will coincide with those visible on the scope screen when the generator output characteristics were checked (Fig. 408). The degree of mismatch will be indicated by the degree of deviation between these two sets of traces.

If the degree of mismatch is large, various types of matching systems such as stubs, baluns or impedance-matching transformers

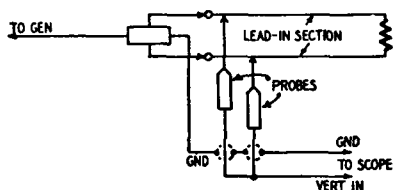

Fig. 413. Diagram of two conventional crystal probes used in balanced tests.

may be inserted between the line and the load until the desired match is indicated by the traces visible on the scope screen. You can construct your own coaxial baluns, if you wish, by following the instructions given beginning on page 73.

If the technician finds that the display is nonlinear (as shown in Fig. 410) when the lead-in length is reduced to zero, the best procedure is to use a grease pencil (China marking crayon) to indicate the shape of this display on face of the cathode-ray tube. The penciled curve becomes the reference curve and is the curve that will be obtained when a section of lead-in under test is properly terminated. Any deviations in waveshape from this penciled curve clearly indicate that the section of lead-in is improperly terminated.

If it is desired to use a pair of conventional crystal probes instead of a special balanced probe, the test setup will appear as shown in Fig. 412. Each of the conventional probes is merely substituting for the diodes shown in Fig. 406. The circuitry used in the dual-probe arrangement is shown in Fig. 413.

Transmission line losses

In Fig. 403, although the line termination is a short or an open circuit, the standing-wave pattern seen on the scope screen when a sweep test is made may not quite touch the zero-volt reference line. The standing-wave pattern will touch that reference line only if there are no losses in the line. When the test frequency is increased, the line losses increase, and the standing-wave pattern approaches the zero-volt reference line less closely for an

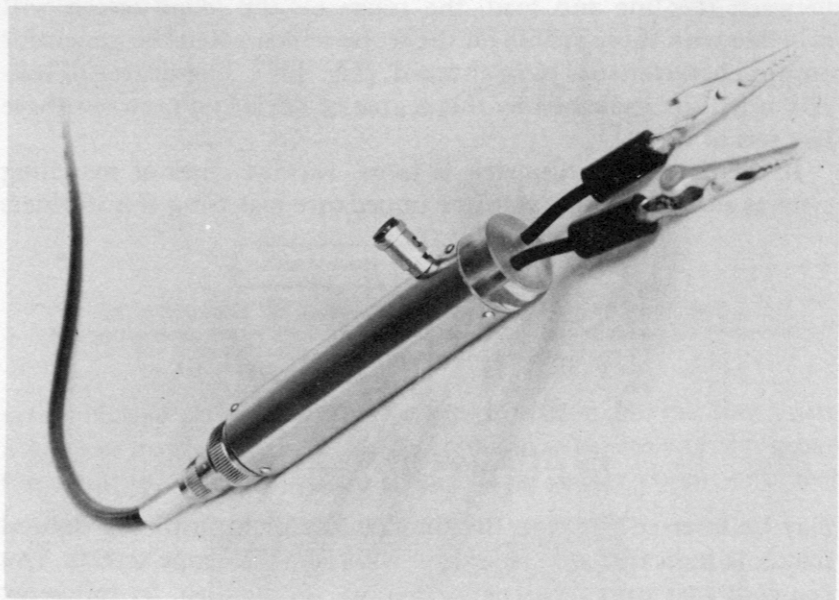

Fig. 414. Photo of balanced probe. The ground connector is fastened to the probe housing.

open or a shorted termination. The amount by which the pattern fails to reach the zero-volt reference line is a measure of the loss in the line.

Construction of a balanced probe

Balanced probes are available commercially. Fig. 414 shows the outside appearance of one such probe. The ingenious technician, however, can construct his own probe from materials he has available in his own shop. Figs. 415-a and -b are sketches showing how miscellaneous materials can be adapted regardless of shape to produce satisfactory results. The probe should be carefully shielded to prevent undesired signal pickup.

Despite the outward appearance of the balanced probe, the

following basic procedures must be adhered to in its construction if it is to operate satisfactorily:

Insulating materials must be of high quality. Short leads are required. Components must be utilized which are designed for use at high frequencies. Resistors should be of noninductive

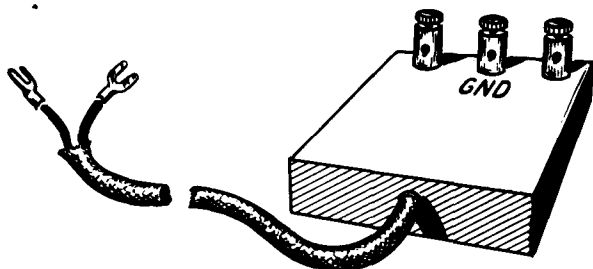

Fig. 415-a. A possible design for a balanced-probe housing.

carbon, and all capacitors should be disc ceramic or of a design approved for use at high frequencies. The circuit and component values for a balanced probe are shown in Fig. 416.

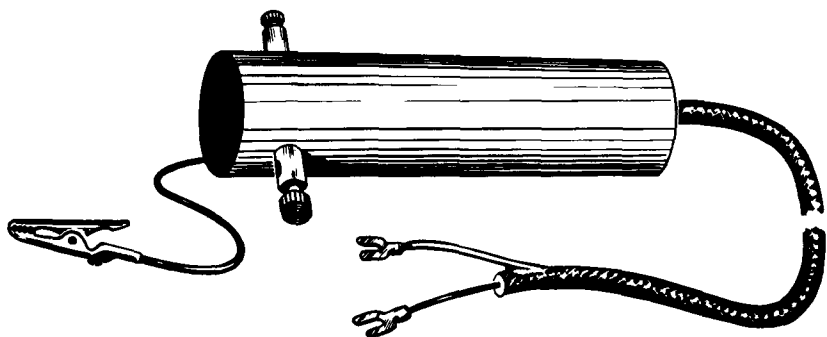

Fig. 415-b. This probe housing follows more conventional design. The two binding posts should be insulated from the housing.

The parts used in the construction of the balanced probe are three $270\text{-}\mu\text{f}$ (approximately) ceramic capacitors, four $120,000\text{-ohm}$ carbon resistors and two 1N34A germanium diodes. The two diodes do not conduct simultaneously and are connected so that when the signal to one diode is positive the signal to the other is negative. This connection keeps the load balanced and, since only one diode is conducting at a time, the resultant output of one will not cancel the output of the other.

To confine the r.f. component of the demodulated signal to the probe head, the R-C network shown in Fig. 416 must be utilized. This network allows the low-frequency components to reach the scope, at the same time bypassing the high-frequency components to ground.

Checking gain and response of TV boosters

This discussion of the use of the balanced probe should not be concluded without mention of the fact that this instrument also is ideally suited for checking gain, response characteristics

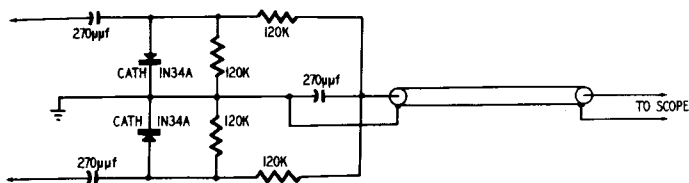

Fig. 416. Circuit diagram of a balanced probe using R-C filter. This can easily be built into either type of housing illustrated in Figs. 415-a or b.

and alignment of TV boosters. By connecting booster and instruments as shown in Fig. 417 and applying the balanced probe first to the booster input and then to the booster output, the tech-

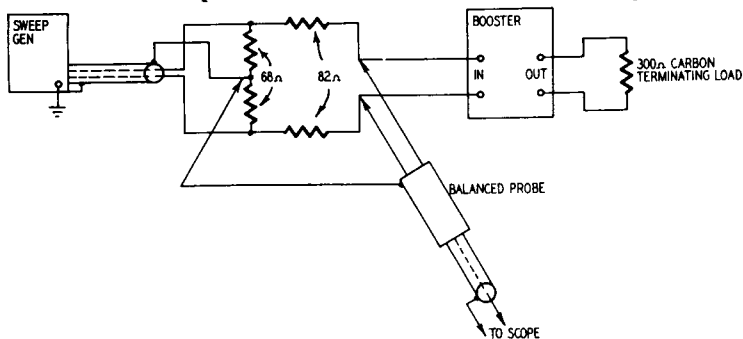

Fig. 417. Setup for using the balanced probe for running tests on TV boosters.

nician can check the gain. By comparing the amplitudes and waveshapes encountered, he can determine the characteristics of the booster.

This setup may be used to check the efficiency and response characteristics of any coupling device encountered in TV distribution systems, if you merely substitute such device for the booster.

Coaxial balun

The output of nearly all signal generators used for service work is approximately 72 ohms. The coaxial cable that brings the signal out of the generator is designed to have this same impedance, so that there is no question of impedance mismatching when the cable is connected to the generator. If the TV receiver being serviced has a 72-ohm input, the coaxial cable of the generator can be connected directly to the antenna terminals, and once again all impedance matching requirements will have been satisfied.

However, the majority of TV receivers being manufactured today have a balanced input of 300 ohms. This impedance can be represented by a 300 ohm resistor, center-tapped to ground, as shown at the right in Fig. 418-a. An impedance of this kind is referred to as *balanced* since the impedances from each side of the input to ground are equal. Signal generators and coaxial cable have unbalanced output because the center-tapping arrangement does not exist with such equipment. We then have the problem

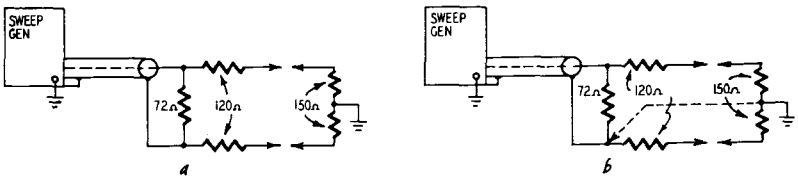

Fig. 418-a,b. These two illustrations show one technique that can be used for getting balanced output from a sweep generator. This method does not give a perfect impedance match.

of matching an unbalanced 72-ohm signal generator output to balanced 300-ohm TV receiver input.

One of the techniques for doing this is shown in Fig. 418-a. A 72-ohm carbon-type resistor is shunted across the coaxial-cable output. A pair of 120-ohm resistors are connected, one to each end of the 72-ohm resistor. The free ends of the 120-ohm resistors now supply the signal output voltage.

Now let us see how this arrangement works when connected to a 300-ohm balanced source, as shown in Fig. 418-b. The two 150-ohm center-tapped resistors could represent the input impedance of a balanced probe or the antenna terminals of a TV receiver.

By examining the circuit we can see that the 72-ohm resistor matches the impedance of the coaxial cable exactly. However, one side of the coaxial cable is grounded and so is the center-tapped input receiving the signal. If you will examine the dashed line in

Fig. 418-b you will see that since one side of the generator output cable is connected to ground one side of the balanced load will tend to be of a lower impedance than the other. Thus, our 300-ohm center tapped load is connected to 192 ohms on one side (120 ohms plus 72 ohms) and to 120 ohms on the other side.

Instead of a resistive network you can make use of a coaxial balun as shown in Fig. 419. A balun is very simple and consists simply of a section of coaxial cable bent back on itself and connected to the signal generator cable. The coaxial balun has fairly good broadband characteristics, and if you cut the balun for the center of each channel in your area, you will have a system that will work. The length of the balun is based on the formula:

$$\text{Length} = 492V/f$$

In this formula the length is in feet, f is the frequency in megacycles, and V is the velocity factor of the cable. For widely used

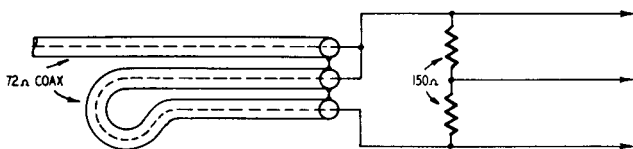

Fig. 419. The coaxial balun is simply cable bent back on itself as shown, and connected to the output cable of the generator. The balun gives a 4:1 impedance match.

cables such as RG11U and RG59U the velocity factor is 0.66. You can use this formula to find the length of a particular balun you may wish to build, or you can use Table 4 if you prefer.

Table 4—LENGTH OF BALUN FOR TELEVISION CHANNELS

Channel number	Frequency, megacycles	Center frequency	Balun length, feet
2	54-60	57	5.69
3	60-66	63	5.15
4	66-72	69	4.70
5	76-82	79	4.11
6	82-88	85	3.82
7	174-180	177	1.83
8	180-186	183	1.77
9	186-192	189	1.71
10	192-198	195	1.66
11	198-204	201	1.61
12	204-210	207	1.56
13	210-216	213	1.52

low-capacitance probes

Low-capacitance probes are extremely useful for tracing waveforms in high-impedance, high-frequency and wide-band circuits (such as are found in TV receivers) without distortion from overloading or frequency discrimination.

It is important to note that scopes vary in input impedance. This statement applies, not only to scopes made by different manufacturers, but also to those of one manufacturer and even units of one model. The service technician, therefore, must adjust his probe to his particular scope. A variable resistor in the probe is used to obtain the desired attenuation of the input signal and a variable capacitor in the probe provides adjustable frequency compensation. This type of probe when used with a scope is particularly valuable for TV sync signal tracing and general tests in video, sync and sweep circuits.

Circuit loading

Circuit loading can occur when the impedance of the circuit under test is sufficiently high so that the sum of the input capacitance of the scope, the probe and its test cable, shunts the higher-frequency components of the waveform to ground.

Probe attenuation

The low-capacitance probe attenuates the signal under test by a factor as great as the factor by which it multiplies the input re-

sistance of the scope. For example, suppose the resistor in the probe is 33 megohms and that the input resistance of your scope is 3.3 megohms. The attenuation factor of the probe then is $33.3/3.3=10/1$. This means that the attenuation factor of the probe is ten-to-one. Using the same probe, but a scope whose input resistance is 2.2 megohms, the attenuation factor is $33/2.2=15/1$. In this case we have a fifteen-to-one attenuation. The lower the input resistance of your scope, the greater will be the reduction in strength of the signal voltage you are testing. If you do not know the input resistance of your particular scope, you can get it by writing to the manufacturer of the instrument.

While you can use any factor you wish, an attenuation of 10 is considered the best compromise for factors such as input impedance and attenuation, besides being most convenient when a scope calibrator is used. It is therefore recommended that a resistor having a value ten times greater than the input resistance of your scope's vertical amplifiers be used in your low-capacitance probe. There is no objection to using other resistor values to obtain any desired attenuation factor, but keep in mind that perfect frequency compensation will generally not be possible if the attenuation factor greatly exceeds 15. If the attenuation is too high, the waveform seen on the scope may be too small.

Measuring probe attenuation

If you know both the value of resistance in the low-capacitance probe and the input resistance of your scope, the attenuation factor can be calculated in the manner described in the preceding paragraphs. However, if you do not have this information, you can easily measure the value of probe attenuation. Connect a pair of jumpers between the vertical input terminals of your scope and a sine-wave generator (audio generator) set at about 1,000 c.p.s. Adjust the output of the generator until the peak-to-peak deflection fills a convenient number of divisions on the scope graph. Without further adjustment of the generator or scope controls, disconnect the jumpers. Now connect the probe tip to the output of the audio generator. The ground clip of the probe should go to the ground terminal of the generator. Similarly, the output leads of the probe should connect to the vertical input and ground terminals of the scope. Actually, what you have done is substituted your low-capacitance probe for the jumpers. The sine-wave signal will now be seen once again on the scope screen, but because of the use of the probe will be con-

siderably weakened. Divide the number of vertical divisions occupied by the pattern when direct connections were used by the number of divisions occupied by the pattern when the probe is used. The answer is the probe attenuation.

For example, if, when using direct connections between the audio generator and the scope, the displayed sine wave occupied 40 squares but only 4 squares when the probe was used, then the attenuation factor is $40/4 = 10/1$.

A low-capacitance probe comprises a shielded resistor-capacitor network which increases the effective input impedance at the probe tip by a factor of 10 or more and, in so doing, attenuates the input

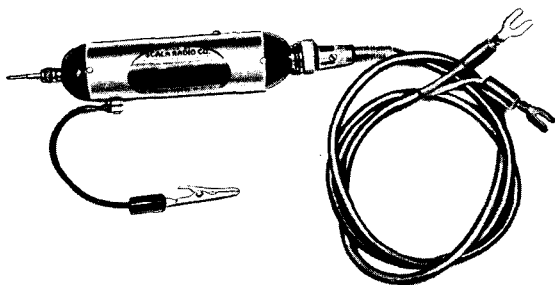

Fig. 501. A 10-to-1 low-capacitance signal-tracing probe.

signal to the probe by a similar amount. In certain TV servicing operations this necessary attenuation of the signal is a useful feature of the probe. In other applications, the attenuation is not required and is recovered by advancing the vertical gain control of the scope.

Numerous technical factors are involved in the construction of a satisfactory low-capacitance, high-impedance probe. The attenuation factor is generally made 10-to-1 so that, once a scope has been calibrated for measurement of peak-to-peak voltages, the use of the probe does not destroy this calibration factor; a zero is merely added to the initial calibrating factor. Such a low-capacitance probe must be compensated against frequency and phase distortion. In other words, the time constant of the probe must be made equal to the time constant of the scope input circuit.

A low-capacitance probe must be constructed not only to have

minimum stray capacitance to the probe shield, but must also be designed to attenuate voltages to protect suitably the scope input circuit whenever you test waveforms having high-amplitude peaks.

A commercial type 10-to-1 low-capacitance test probe is shown in Fig. 501. Two screw adjustments are provided. One of these is used to obtain the proper frequency compensation for the probe and the other to get the correct amount of signal attenuation.

Probe design

When designing a low-capacitance, 10-to-1 voltage-divider probe, the capacitance of the cable and the input capacitance and impedance of the scope must be considered. These form a part of

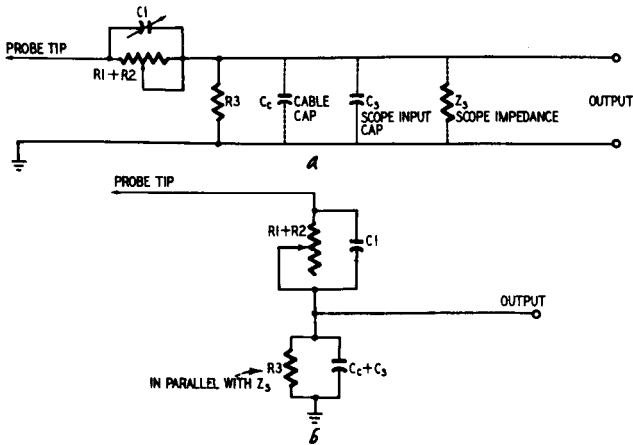

Fig. 502-a,-b. Circuit factors involved in the design of a low-capacitance probe. The circuit, a, is rearranged as in b, to show divider action. See footnote for explanation of probe adjustment.

the divider network as shown in Fig. 502-a,-b. R_3 is necessary to provide a divider network for the d.c. component present at the point under test.*

*Examining Fig. 502-a,-b once again, we will have for proper response (bandwidth):

$$C_1 (R_1 + R_2) = \left(\frac{R_3 Z_s}{R_3 + Z_s} \right) (C_c + C_s)$$

For a 10-to-1 attenuation, R_2 should be adjusted so that

$$R_1 + R_2 = 9 \left(\frac{R_3 Z_s}{R_3 + Z_s} \right)$$

and C_1 must be adjusted so that

$$C_1 = \frac{C_s C_c}{9}$$

The circuit shown in Fig. 503 gives component values for those who wish to construct their own low-capacitance probes. Trimmer capacitor C1 should be capable of being adjusted to a value equal to the combined capacitance of the probe cable plus the input capacitance of the scope. The input capacitance of the scope depends upon the make. For this reason you may have to

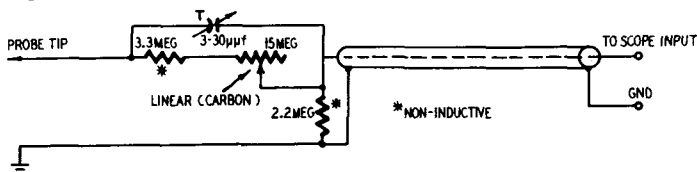

Fig. 503. Component values for a typical low-capacitance probe.

use a larger value trimmer capacitor than that shown in Fig. 503. The cable should be chosen for low capacitance, a type such as RG-59/U being satisfactory. Since the cable does add capacitance, keep the cable length below 3 feet.

The low-capacitance probe shown in Fig. 503 does not use a blocking capacitor. Special low-capacitance probes are available which do not offer a d.c. path to ground. A circuit of such a probe is shown in Fig. 504. The .05- μ f capacitor is used to keep d.c. out of

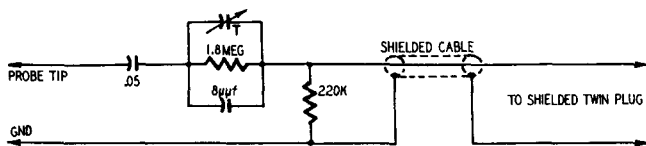

Fig. 504. The capacitor in series with the probe tip blocks d.c., permits passage of a.c. waveforms.

the input to the scope, yet the capacitance of this blocking unit is sufficiently large to permit passage of low-frequency waveforms. You can build the probe into a housing of the type shown in Fig. 505. The compensating capacitor and the potentiometer do not have knobs, but can have slotted shafts for screwdriver adjustments. This arrangement avoids the annoyance of protruding knobs and minimizes the possibility of accidentally misadjusting the probe.

Use of probe in high-impedance circuits

A low-capacitance probe should be used in any video, sweep or sync circuit in which the input capacitance of the scope is sufficient to load the circuit under test and thereby produce high-frequency distortion and phase shift.

In Fig. 506 we see a low-capacitance probe being used to check the horizontal sync waveforms in the automatic gain control circuit

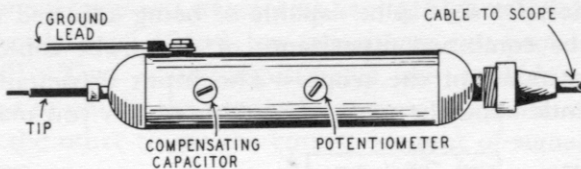

Fig. 505. External details of probe housing. Two variable adjustments are provided.

of a television receiver. A close-up, cut-away view of this same probe is shown in Fig. 507.

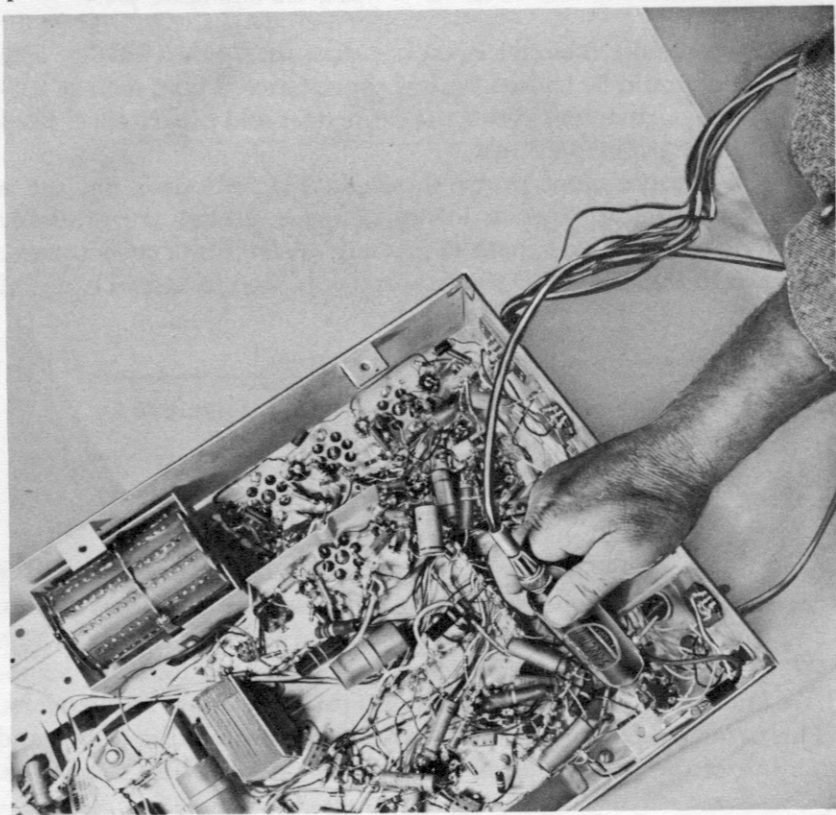

Fig. 506. Photo of low-capacitance probe at work checking waveforms in a TV receiver.

Another important application is the testing of video amplifiers by means of 100-kc square waves (the preferred method of video-

amplifier testing). Unless the scope is applied to the signal input of the picture tube by means of a low-capacitance probe, the response of the video amplifier will appear to be faulty at the higher video frequencies. In other words, the input capacitance of the scope will load the output circuit of the video amplifier abnormally and round off the square wave considerably.

The operator should note, however, that the scope must have a better response than the video amplifier under test. If the vertical amplifier is limited in response, the next best pro-

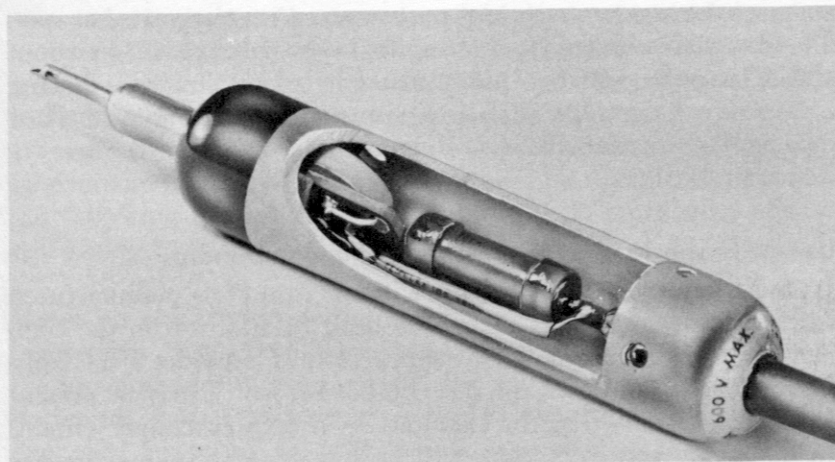

Fig. 507. Cut-away view of the interior of a low-capacitance probe showing placement of parts.

cedure is to apply the output from the video amplifier directly to the deflection plates of the cathode-ray tube in the scope. In either procedure the socket should be removed from the picture tube to eliminate this source of excessive capacitive loading during test.

Use of probe in high-voltage circuits

Although the chief function of the low-capacitance probe is to provide low input capacitance, and hence to minimize circuit loading, the probe also finds application in TV trouble-shooting procedures on the basis of its 10-to-1 attenuation factor. It can, for example, be used to test the waveform across the horizontal deflection coils. In typical TV receivers this waveform has a peak-to-peak voltage of 1,400. This is beyond the voltage-handling capability of the usual service scope. Even if this voltage does not damage the scope input circuit, the horizontal amplifier will

be overdriven in many cases and the waveform on the scope screen will be distorted accordingly. Use of the 10-to-1 probe cuts this voltage down to 140, which is well within the voltage-handling capability of a scope.

When speaking of high voltage in a TV set, most technicians automatically think of the e.m.f. at the second anode of the picture tube or at the filament side of the high-voltage rectifier tube. However, voltage, in the form of pulses, must also be considered. As an example, the pulse voltage at the plate of the horizontal output tube is very much higher than the d.c. voltage at that spot. The d.c. plate voltage (including the boost voltage) will be about 400. The pulse will be approximately 3 to 6 kilovolts. Placing a scope (or v.t.v.m.) at such test points without using a capacitor type voltage-divider probe will immediately damage the test instrument.

Use of probe in circuits with high d.c. component

One commercial type low-capacitance probe* is manufactured with a shunt resistor in the probe head in addition to the compensated series resistor. This shunt resistor provides a d.c. voltage divider to cut down the d.c. component which may be present with the a.c. signal, as for example, in a booster-damper circuit. In many TV receivers there will be found a d.c. booster output of 600 to 650 volts, to which is added the peak voltage of the a.c. waveform under test. Such high d.c. voltages are sufficient to damage some scope input circuits when a substantial peak a.c. voltage is also present. The construction of the probe avoids this possibility of damage to the scope.

Probe response vs. scope response

The frequency and phase characteristics of the low-capacitance probe can far exceed the capabilities of most scopes available to the service technician. Accordingly, distortion at higher frequencies will be localized to the vertical amplifier of the scope rather than to the probe.

There are some scopes in use which are not provided with compensated step attenuators. Such scopes will develop less bandwidth at higher attenuations. Furthermore the input resistance and capacitance of such an input circuit is not constant and

*Scala Model BZ-2.

cannot be matched by the probe at all attenuator settings. Keep in mind that a probe *cannot* improve the characteristics of your scope. In other words, the probe is no better than the scope with which it is used.

"Allowing for" scope distortion

It is sometimes claimed that a scope with limited response characteristics can be used in wide-band receiver circuits by "allowing for" the scope distortion. Although this procedure may have some limited utility in special cases with which the operator has great familiarity, the dangers involved are very great and serious trouble shooting should not be undertaken upon such a basis. The operator will also recognize the fact that if a scope has 1% response at 1 mc, for example, waveform details developed by components between 1 and 2 mc will be completely lost and the "allowing for" procedure is actually little more than crystal-ball gazing.*

Notes on calibration of the scope

Effective (r.m.s.) voltages can be applied accurately only to the measurement of symmetrical sine waves. The amplitudes of trapezoids, pulses and other irregular waveforms are generally expressed in terms of peak-to-peak, positive or negative peak voltages, which can be read on a scope.

It is easy to measure peak voltages if you know the relationship between such voltages and a sine wave. The easiest way is to calibrate your scope in terms of a sine wave. To do this, it is necessary to have a graph in front of your scope screen. Such graphs, made of plastic, generally come with the scope when purchased, or can be obtained separately. These plastic graphs are easy to attach or remove from the face of the scope tube.

A comparison between a trapezoid and a sine wave is shown in Fig. 508. Trapezoidal waveforms are found in vertical and horizontal sweep circuits of TV receivers. By calibrating a scope in

*The chief exception to this observation is utilization of a scope which has the IRE roll-off characteristic. Although of limited bandwidth, a scope with this amplifier characteristic will reproduce video waveforms without severe distortion except that narrow spikes caused by faulty circuit operation will be greatly shortened. In particular, a limited-bandwidth scope with the proper roll-off characteristic has the merit of not developing within itself such spikes or overshoots when waveforms having frequency components considerably beyond the bandwidth of the scope itself are under test.

terms of a sine wave, you can measure peak-to-peak, positive peak, and negative peak values of a nonsymmetrical waveform (such as a trapezoid).

The low-capacitance probe is most useful when the scope has been calibrated in terms of peak-to-peak volts per square. A scope is usually calibrated from a sine-wave source because such sources are readily available and also because the relationship between the r.m.s. value of a sine wave and its peak-to-peak value is known.

In most service procedures the voltage difference between the r.m.s. and peak-to-peak values of a nonsinusoidal waveform will not be known and trouble shooting will be done upon the basis of peak-to-peak voltages alone. Once a scope has been calibrated in terms of peak-to-peak voltage, any waveform may be applied

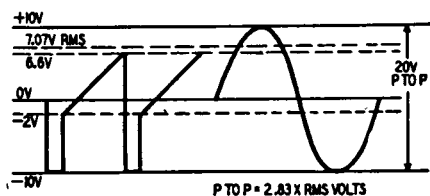

Fig. 508. The amplitudes of trapezoids, pulses, and other irregular waveforms are generally expressed in terms of peak-to-peak, positive-peak, or negative-peak voltages, which can be read on a scope.

to the input of the scope and its peak-to-peak voltage can be read from the screen of the scope.

To calibrate a scope it is essential to know that the peak-to-peak voltage of a sine wave is 2.83 times its r.m.s. (effective) value. The r.m.s. value of a sine wave is usually indicated by conventional a.c. service voltmeters. The peak-to-peak voltage of a 6.3-volt r.m.s., a.c. wave is equal to 17.83 peak-to-peak volts ($6.3 \times 2.83 = 17.83$, or 17 volts approximately).

To calibrate your scope, use the 6.3-volt post of the test instrument for your sine-wave source, as illustrated in Fig. 509. If your scope does not have such a voltage terminal, any 6.3-volt filament transformer will do or you can use the filament voltage of the TV set itself. (Do not connect to low-or-high-voltage rectifier filament.)

No matter what a.c. voltage source you use for calibrating the scope, the procedure is the same. Connect the a.c. voltage between the vertical input terminal of the scope and the ground

Fig. 509. (1) Connect the 6-volt a.c. post to the vertical post with a jumper (or use direct probe). (2) This will produce a screen pattern whose peak-to-peak value is 17 volts (6 volts r.m.s. \times 2.83=17 volts peak-to-peak).

(3) The height of the 17 volt peak-to-peak wave on the screen depends upon the setting of the vertical gain control and the setting of the attenuator (vertical sensitivity switch).

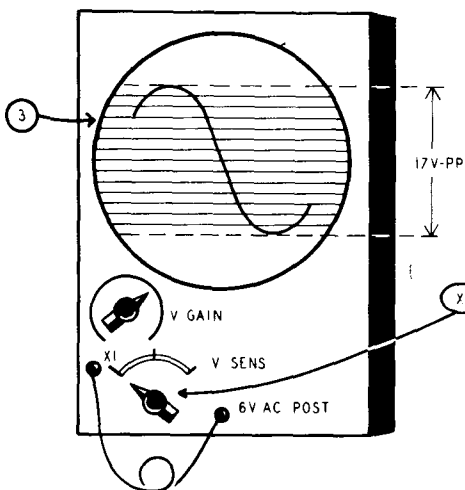
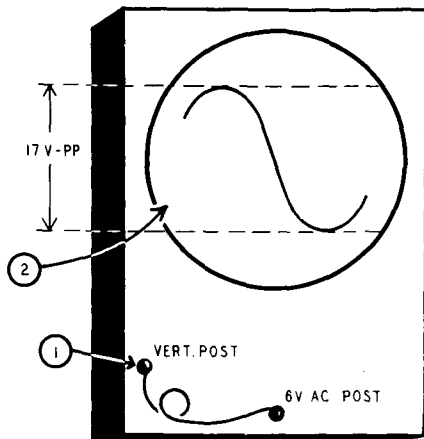
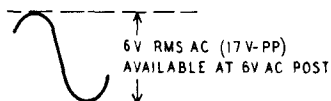

For example, with the vertical sensitivity switch set to $\times 1$ position, adjust the vertical sensitivity control until a 17 volts peak-to-peak pattern occupies a total of 17 squares. Remove the jumper.

Now, as long as the sensitivity and gain controls are left untouched, the scope is calibrated

so that each vertical square equals 1.0 volt.

The same procedure could have been used with the vertical sensitivity switch set to $\times 10$ position. This puts the vertical gain control at a lower setting.

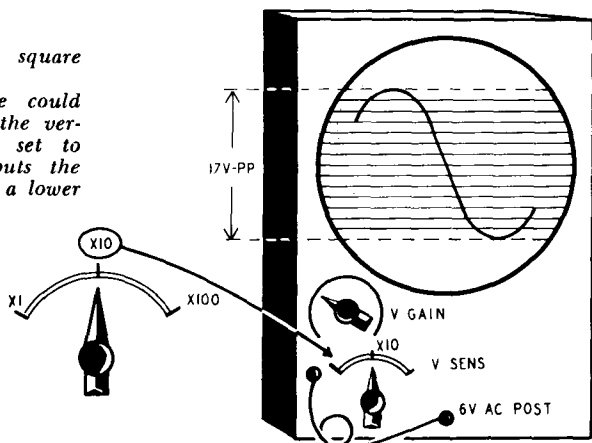
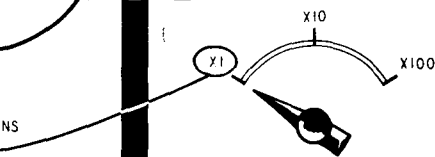

terminal. Advance the vertical gain control (vertical attenuator) until the sine waveform on the screen occupies 17 squares. Each square then represents 1 peak-to-peak volt.

Although we have given here an example of calibrating the scope for a value of 1 peak-to-peak volt per square on the graph, you can calibrate for other values as well. For example, the scope can be calibrated for a sensitivity of 10 or 100 peak-to-peak volts per square. This is very much like having a voltmeter with a multiplier control so that you can read 1, 10 or 100 volts. It is desirable in such procedures to utilize a decimal calibration factor (factor of 10) since the screen can be read that much more rapidly. Furthermore, if the probe is a 10-to-1 type, this provides a decimal attenuation factor when used and in effect multiplies the calibration factor of the scope by a factor of 10.

For example, if the probe has been calibrated at 10-peak-to-peak volts per square, the calibration will become 100 peak-to-peak volts per square when the probe is attached to the scope. Most service scopes are provided with 10-to-1 step attenuators. Such a step attenuator also ties in with decimal calibration—either multiplies or divides the calibration factor of the scope by 10 when advanced or dropped a step.

During calibration the vertical gain control can be set in any convenient position. Once set, it should not be touched again. Should the vertical gain control be turned accidentally, the scope will have to be recalibrated. Some scopes come equipped with a vertical sensitivity control in addition to a vertical-gain control. The vertical sensitivity control is a voltage-divider network, similar to that used on a v.t.v.m. or multimeter. Like these instruments, the voltage divider ordinarily has X1, X10 and X100 scales. You can set your scope control to any one of these positions when you calibrate. If you use the X1 position, the scope will be calibrated at 1 volt per square. In the X10 position, the scope scale will be 0.1 volt per square and it will be .01 volt per square when you set the vertical sensitivity control (or attenuator) to the X100 position.

Now suppose you calibrate with the vertical sensitivity control set to X10. The scope scale will be 1 volt per square in this position, and 0.1 volt per square in the X100 position. Naturally, in the X1 position you will be reading 10 volts per square. Most plastic graphs used with scopes are removable. Make sure that the X-axis of the graph is horizontal; then do not touch it.

Basic properties of nonsinusoidal waveforms

The waveform shown in Fig. 510 is a peaked sawtooth wave, consisting of a sawtooth component and a peaking-pulse component. This is a typical sweep waveform. Its proportions serve to illustrate the basic properties of nonsinusoidal waveforms.

When no signal is applied to the scope input, the trace on the screen indicates the 0-volt level. When the peaked sawtooth wave is applied to the scope input, the waveform distributes itself about the zero axis. The distribution is such that the positive area above the axis is exactly equal to the negative area below the axis. This distribution is required because the quantity of positive electricity in a waveform is exactly equal to the quantity of negative electricity, and the scope indicates the quantity of electricity as an area. The waveform of Fig. 510 has a positive peak voltage of 6.6,

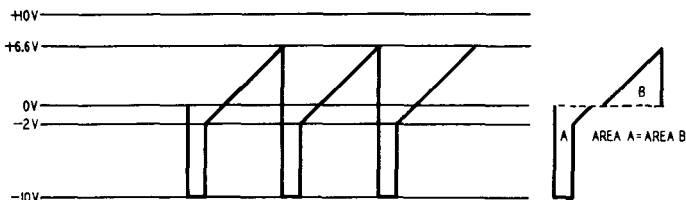

Fig. 510. A trapezoid has a sawtooth and a square wave component.

a negative peak voltage of 10, a peak-to-peak voltage of 16.6, a sawtooth component of 8.6 volts and a peaking-pulse component of 8 volts.

Adjusting the probe

There are a number of techniques that you can use to get the probe ready to work. Adjusting these probes is really a two-step process: The probe must be set for the proper amount of attenuation, and it must also be tuned for proper frequency compensation. After you have set the probe properly you should check it periodically to make sure that it remains in adjustment.

To secure the correct attenuation factor of the probe, connect the vertical input of the scope directly to a 60-cycle sine wave source and adjust the vertical gain on the scope for any convenient number of squares. This completed, disconnect the a.c. source from the scope and connect the probe lead in its place. Now connect the probe tips to the a.c. supply that was removed from the scope and adjust the potentiometer in the probe until you get

the desired amount of attenuation of the waveform. A 10-to-1 attenuation is both desirable and very convenient.

The frequency compensation of the low-capacitance probe can now be adjusted by using a square-wave generator, the sawtooth output of your scope, or a television receiver. Whichever of these techniques you decide upon, the probe must first be adjusted for correct attenuation.

Square-wave generator method

If you have a square-wave generator, connect the output leads of the probe cable to the vertical input terminals of the scope. Connect the probe tip and ground lead to the output terminals

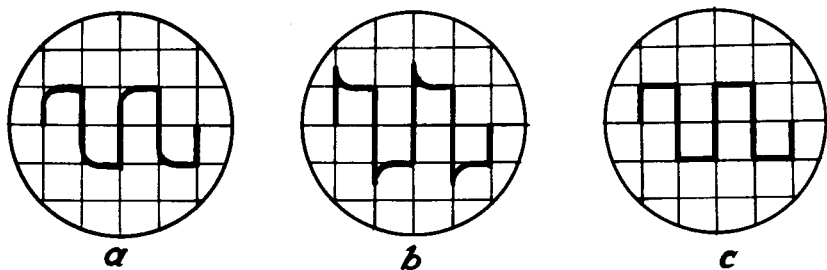

Fig. 511-a,b,c. An improperly adjusted probe will show the waveforms in a and b. Correct adjustment will give the results shown in c.

of the square-wave generator. Set the generator to some frequency between 10,000 and 50,000 c.p.s. Adjust the probe trimmer capacitor with a screwdriver or an insulated alignment tool until the square-wave output of the generator is properly reproduced on the scope screen.

Incorrect trimmer adjustment is indicated by a badly rounded or a badly peaked square wave as shown in Figs. 511-a and 511-b. A correctly adjusted probe will produce the waveform illustrated in Fig. 511-c. To make this test your scope should have a flat response to a frequency 10 times greater and 10 times smaller than the fundamental frequency of the square wave in order to reproduce it with good fidelity.

Sawtooth method

You can use the sawtooth output of your scope multivibrator to adjust the frequency compensation of your probe. In some com-

mercial scopes the sawtooth voltage is available at a front-panel jack. If the sawtooth is not brought out to the front panel, take the scope chassis out of its cabinet. Connect the output leads of the probe to the vertical input of the scope. Touch the probe tip to the input grid of the horizontal output stage. Set the scope for internal sweep and the sweep frequency to about 1,000 c.p.s. Adjust the vertical and horizontal gain controls of the scope until the pattern fills about two-thirds of the screen. The sync control on the scope should be set to the minimum value that gives good lock-in of the waveform.

If the probe trimmer is not properly adjusted, the pattern will appear as in Figs. 512-a and 512-b. Note the hook at the end of the trace. Adjust the probe trimmer until this hook disappears and the pattern is as shown in Fig. 512-c. On some scopes, the

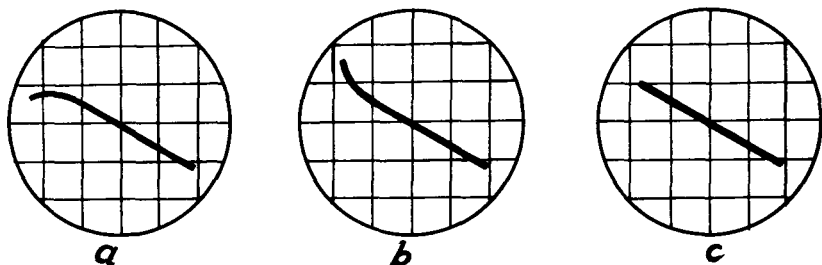

Fig. 512-a,b,c. Improper adjustment of probe trimmer produces hooks shown in a and b. Probe is adjusted when hook disappears (c).

waveforms illustrated in Figs. 511 and 512 will be found transposed from left to right or inverted or both. Such positioning will have no effect on the adjustment of your probe and can be disregarded.

Television receiver method

Using a properly operating television receiver tuned to a strong signal, touch the probe to the output of the video amplifier. On the scope observe the video signal input to the picture-tube socket with the picture tube removed. Adjust the compensating capacitor in the probe until the equalizing pulses that you see on the scope screen are equal in amplitude to the vertical sync pulses. Set the capacitor so that the pulses are neither rounded nor peaked.

Whichever method you use, you will have adjusted your probe for the amount of attenuation you want and you will also have tuned it for correct frequency compensation.

Extending voltage range of probe

By using a low-capacitance, voltage-divider probe and also by taking full advantage of the vertical gain and sensitivity controls of your scope, you can measure an extremely wide range of voltages. The maximum input voltage range of the scope is extended to approximately 1,500 volts peak-to-peak, where the greatest magnitude of the waveform is *either* positive or negative, and to 3,000 volts peak-to-peak for symmetrical waveforms.

If you need to measure a voltage and you suspect that the peak-to-peak magnitude is greater than 1,500 volts, or if you don't know the relative proportions of the negative and positive parts of the wave, then you should connect a capacitor to the probe tip. The working voltage of the capacitor should be equal to (or higher) than the peak-to-peak voltage you expect to measure. The voltage you test will distribute itself between this capacitor and the one in the probe. The capacitor should have a value of about .005 μf .

You'll have trouble with the capacitor flopping around if you try simply to wrap the capacitor lead around the probe tip. Make the capacitor into an adapter unit, with one capacitor lead going to a female connector (such as a pin jack). This can then be slid onto the needle-point end of the probe. The other end of the capacitor can be soldered to a tiny clip or point, whichever you prefer. Mount this very simple unit in a small plastic tube and keep it with your set of probes.

Tracing the TV sync signal

With a low-capacitance probe you can trace the progress of sync pulses (both horizontal and vertical) all the way from the output of the video sound detector right up to the inputs to the vertical and horizontal oscillators. The procedure here is almost the same as though you were signal tracing in an ordinary radio receiver.

You can start with your low-capacitance probe (connected to your scope) at the output of the video second detector, follow the sync pulses through the video amplifier, sync separator, sync amplifiers, and then through the differentiating and integrating networks. In this way you can quickly determine which circuit is causing loss of sync.

You can also use this probe for testing the efficiency of a sync discriminator and reactance tube circuit in horizontal a.f.c. systems. The probe will help show the waveshapes indicated in the circuit diagram for the receiver. Knowing the required wave-

shapes at various points of a Synchrolock circuit, Synchroguide or any other type of horizontal a.f.c. system, and using your low-capacitance probe and scope, will speed up trouble shooting.

Since a TV receiver is a pulse-operated device, proper waveshapes are required for trouble-free operation of the set. While a d.c. voltage check is useful and desirable, it is entirely possible for a particular tube to show normal operating voltages but still not operate properly because of faulty triggering or pulse voltages at the input. Since the probe is the device that transports the pulse from the TV set to the scope, obviously the probe must do nothing to change the shape of that pulse. If the probe does affect the pulse waveshape, then quite obviously the scope will not show you a condition as it actually exists at the point under test.

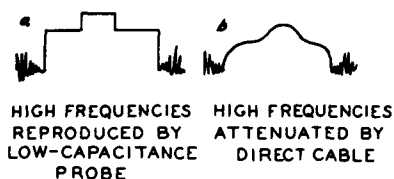

Fig. 513-a,b. *Difference in waveforms reproduced on scope screen when using low-capacitance probe (a) and direct cable (b).*

For example, a blanking and sync pulse might appear as shown in Fig. 513-a when using a low-capacitance probe. If, instead, a shielded direct cable is used, then attenuation of the high frequencies might appear as shown in Fig. 513-b. When using a direct shielded cable, high-frequency loss is indicated by rounding of the pulse edges, a condition not existing in the receiver and caused by the cable. Misleading information of this type can cause loss of valuable servicing time.

Testing the vertical blocking oscillator

It is often necessary to make a check of the pulses at the control grid of the vertical blocking oscillator. In this circuit the oscillator grid leak is sometimes as high as 10 megohms. The technician who attempts to test such a circuit will find that the input impedance of a direct cable to the scope is *far too low* for this application. Its capacitance will shunt the oscillator tank circuit and will cause a loss of signal voltage, perhaps seriously disturbing circuit operation.

Use of a low-capacitance probe will eliminate the first of these troubles, but it will usually introduce another. The *input resistance* of the probe, being less than 10 megohms, will drain away too much of the d.c. bias voltage, again seriously disturbing circuit operation. Just as a simple example, let us suppose that the grid leak of a particular vertical blocking oscillator is 5 megohms and that the probe placed at the control grid also has a resistance to ground of 5 megohms. The two resistances are now effectively in parallel, thus cutting the d.c. bias voltage on the tube in half. When this difficulty is encountered, the technician must use a

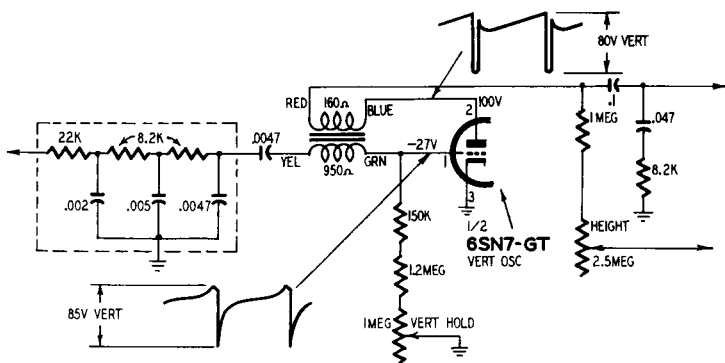

Fig. 514. Typical input and output waveforms in vertical-blocking oscillator circuit. These can be checked with low-capacitance probes.

blocking capacitor in series with the low-capacitance probe. Naturally, such a precaution is not necessary if the probe has a blocking capacitor built in as part of the unit.

A vertical blocking oscillator in a TV receiver can be easily tested with a v.t.v.m. simply by setting the test instrument to read d.c. volts and putting the clip leads across the grid-return resistor. The amount of bias voltage measured will give you an idea of how energetically the oscillator is working. While this test is an easy and quick one, it tells you nothing about the shape or amplitude of the vertical pulse coming into the control grid of the tube from the integrating network. Actually, the vertical oscillator does not need this pulse in order to operate, hence a v.t.v.m. bias check doesn't give the full picture.

If you will examine the illustration of the vertical blocking oscillator circuit shown in Fig. 514, you will see that the pulse input to the control grid of the tube is rather sharply spiked. Although these waves come along at the rate of 60 per second,

each waveform has high-frequency components. These high-frequency components can easily be lost, resulting in waveform distortion, if ordinary test leads or shielded cable is used for connection to the scope. The low-capacitance probe reduces the amount of capacitance introduced by ordinary, shielded direct cable, to one-tenth. This means that the high-frequency components of the pulse are not bypassed and are shown on the scope screen.

Testing deflection coils

An ordinary resistance check of the two windings of the yoke will often (but not always) reveal a defective unit. A good test to make is with the TV set turned on and the yoke functioning under actual operating conditions. Resistance checks, if made,

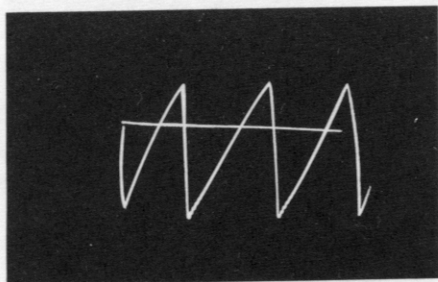

Fig. 515. Photo of current waveform in horizontal yoke.

should be done *before* the set is turned on. When the TV set is working, a very high peak-to-peak voltage exists across the deflection coils. In a typical receiver this will amount to about 1,500 volts peak-to-peak across the horizontal deflection coils. This voltage should never be applied directly to the input of a scope, since it may very well "blow" the capacitor at the vertical input to the scope. In any event, the vertical amplifiers of the scope will be overloaded, producing a distorted waveform on the screen. The voltage-divider action of the probe will reduce the voltage to a safe value.

Unlike radio testing, TV testing is concerned with *shapes* of waves in very many cases as well as with various *types* of voltages. For example, a normally operating TV receiver may produce the typical waveforms illustrated in Fig. 515. This photograph shows the normal *current* trace in vertical or horizontal yoke windings. Note that the current waveform is a sawtooth. The *voltage* appear-

ing across the yoke is a trapezoid, similar in shape to that shown in Fig. 510.

To see the trapezoid, connect the ground clip of your probe to one side of the deflection coil being tested and touch your probe lead to the other side. The trapezoid will appear on the scope screen. Make sure that your scope cabinet does *not* touch the metal chassis of the TV set being tested. You can then adjust the linearity and sweep controls of the TV set to get the best trapezoid.

It is much easier to make such adjustments, however, by watching the sawtooth current wave, rather than the trapezoidal voltage

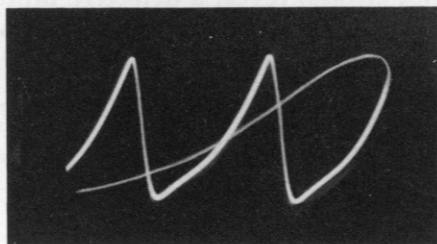

Fig. 516. *Distorted current waveform in horizontal yoke indicates trouble in sweep circuit.*

wave. You can convert the sawtooth current wave to a voltage wave by sending the current through a resistor. This can be easily done by inserting a 5-to 10-ohm 5-watt resistor in series with either lead going from the horizontal output transformer to the yoke.

To see the sawtooth waveform, connect the ground clip of the probe to one side of the resistor and touch the probe tip to the other side. Do *not* ground your scope. Do *not* connect the scope to the chassis of the TV set. Make sure that the scope and TV chassis are separated and can not touch. After the sawtooth appears on your scope screen, adjust the linearity and sweep controls of the TV receiver until the rise portion (forward sweep) of the sawtooth is as straight as possible. You can use the same resistor and make the same linearity checks of both vertical and horizontal sweep. The technique is the same in both cases.

If you will carefully examine the sawtooth shown in Fig. 515, you will see that there is only slight nonlinearity plus a trace of ringing at the start of each sawtooth. A "sick" receiver may produce the waveform shown in Fig. 516. This illustration shows distortion in the horizontal yoke current. The nonlinearity of this

waveform will result in compression of the left-hand side of the picture.

Every little variant has a meaning all its own. The problem of the technician is to learn to read this new language and to be able to spot the receiver component responsible for any existing waveform distortion. Generally speaking, then, whenever you have service checks to make in video, sync and sweep circuits, you should use a low capacitance probe and a scope. Since a high-impedance probe of this kind will not upset the circuits under test, the waveforms that you see will be those that exist at the test points.

High-voltage adapter

There are circuits in a TV receiver in which either the a.c. or d.c. voltage or both may far exceed the rating of the probe. In these cases, it is essential to use a probe with a 100-to-1

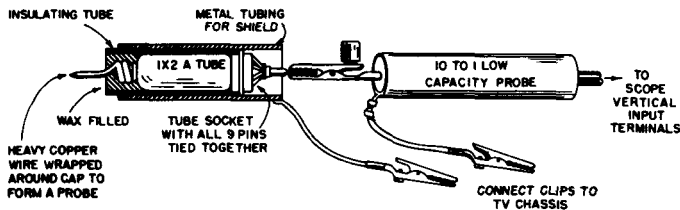

Fig. 517. Technique for using a tube as a high-voltage capacitor.

attenuation factor instead of 10-to-1. High-voltage probes are described in the next chapter. For example, if you want to make tests at high-voltage pulse points such as the horizontal amplifier plate or the plate of the high-voltage rectifier, you must use a 100-to-1 probe. If you do not have such a probe, you can quickly modify your 10-to-1 probe by putting a high-voltage capacitor in series with it. In place of a high-voltage capacitor (rated at 20,000 volts) you can use a 1X2-A as shown in Fig. 517.

No filament or plate voltage is required for the tube. The interelectrode capacitance of the tube will act as a high-voltage capacitor. Solder all nine pins of the tube socket together. Wrap a small piece of heavy copper wire around the tube cap and shape the wire into the form of a probe point. Place the tube into a small section of bakelite tubing. Fill the tubing with wax so that the 1X2-A is held securely in place. You can also use Duco cement or equivalent. Put a metal shield around the insulating tubing. Connect a clip lead to this metal shielding.

An alligator clip should be soldered to one end of this lead.

There are just a few precautions. Whenever you run a check at a high-voltage pulse point be sure to connect the alligator clip lead of the 1X2-A probe to the chassis of the TV set. Your 1X2-A must be in good condition. A tube with a broken filament can cause an internal short, resulting in damage to the probe or scope. The purpose of the shield around the 1X2-A probe is to prevent spurious pick up from the field surrounding the horizontal output transformer.

The 1X2-A adapter should not be used as a substitute for the 100-to-1 probe, but rather as a temporary device until a 100-to-1 probe can be constructed or purchased.

Building a low-capacitance probe

A low-capacitance probe must be used to reproduce faithfully high-frequency waveshapes (15 kc and higher) and to prevent loading of the circuit under observation. Such a probe can be readily constructed with a few parts.

The probe circuit is shown in Fig. 518. Mount the parts on

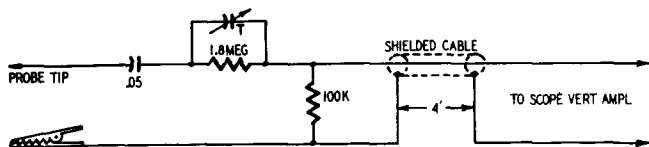

Fig. 518. Here is a simple, easy-to-build, low capacitance probe. Variable capacitor, T, can be a 3-30 μmf trimmer. The capacitance of the cable should be 140 μmf .

a small piece of insulating material such as bakelite or plastic. Do not depend upon soldered connections to hold the parts in place. The probe housing may be a miniature i.f. transformer can or a tube shield salvaged from an obsolete radio receiver. After the components have been mounted on the board, wrap it with a small piece of cellophane or durable Kraft paper. This will prevent shorting of the parts against the inside of the metal can.

A shielded cable must be used with the probe since it will prevent stray pickup. The length of this cable is very important since its capacitance is used in the design of the probe. The total capacitance of the cable must be 140 μmf . In the illustration we show a cable having a capacitance of 35 μmf per foot. For our purposes, then, we would need a cable having a total length of 4 feet. You can use any type of coaxial cable you wish, provided the

total capacitance is $140 \mu\text{f}$. You could, for example, use RG9U rated for $30 \mu\text{f}$ per foot. The cable length would then be 4.66 feet. If you use a cable having a lower capacitance than $30 \mu\text{f}$

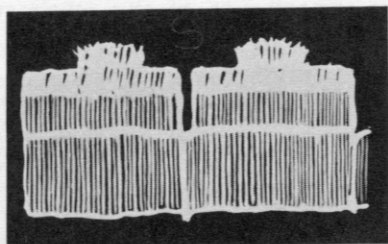

Fig. 519. *A correctly adjusted probe will produce this waveform.*

per foot, you may find that the cable length will be excessive and unwieldy.

The probe is so constructed that the signal at the input terminals of your scope will be $1/15$ th of its value at the point under test. This means that your scope should have a minimum vertical sensitivity of $.05$ r.m.s. volt per inch. Most scopes will meet this requirement.

Adjusting the probe

The probe must be adjusted to match the input impedance of your particular scope. You can do this by any one of the techniques described earlier in this chapter. A simple method is to use a TV receiver known to be in good working order.

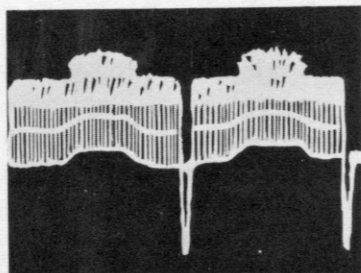

Fig. 520. *Here we see the effect of insufficient trimmer capacitance.*

Connect the probe to the output of the video detector by putting the probe tip at one end of the diode load resistor and connecting the alligator (ground) clip of the probe to the other end of the resistor. Connect the probe output to the vertical input

terminals of the scope. Set the scope sweep to approximately 30 c.p.s. Adjust the trimmer capacitor of the probe so that the vertical blanking pulses and horizontal blanking pulses line up as shown in Fig. 519. If the capacitance of the trimmer is too low, the waveform will appear as in Fig. 520. The waveform will be as

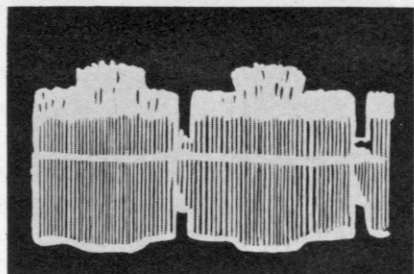

Fig. 521. If the probe trimmer capacitance is too high, this is the result you will get.

shown in Fig. 521 if the capacitance of the trimmer is too large.

high-voltage probes

TV receiver circuits can develop high voltages which are beyond the voltage-handling capability of scope input circuits and which also exceed the voltage rating of simple attenuating probes. For example, the plate of the horizontal output tube in a TV receiver may develop as much as 6,000 peak-to-peak volts. To inspect the waveshape of the voltage and to measure its peak-to-peak value, a 100-to-1 probe is essential.

A representative 100-to-1 probe will have a high input impedance; its input capacitance will be about 1.25 μmf and its input resistance infinite. Such a probe will not noticeably load high-voltage circuits in a receiver, and measured peak-to-peak voltages will be correct. This probe also has high-voltage insulation and will withstand 7,500 peak volts before gas currents develop which disturb the attenuation factor.

This type of probe is not frequency-compensated like conventional low-capacitance probes. The chief reason for this omission is that high-voltage tests are made in horizontal sweep circuits where the highest frequency involved is only about the 10th harmonic of 15,750 cycles.

The probe should be calibrated and adjusted for a 100-to-1 attenuation factor when used with a particular scope. When the probe is used with other scopes, the calibration factor may be slightly in error. The probe should be of shielded construction to avoid stray field pickup which would distort the display.

A commercial 100-to-1 high-voltage, capacitance-divider probe

is shown in Fig. 601. The head is made of special insulating material to withstand severe potentials in TV high-voltage supply networks. In Fig. 602 we have the 100-to-1, capacitance-divider probe being used in the high-voltage cage of a TV receiver.

Probe design

The various capacitances of a high-voltage divider probe are shown in Fig. 603. C1 is a high-voltage capacitor or a tube acting as a capacitor. Trimmer capacitor C2 is adjusted for a 100-to-1 voltage ratio with a given cable and scope.

The input impedance of a high-voltage, capacitance-divider

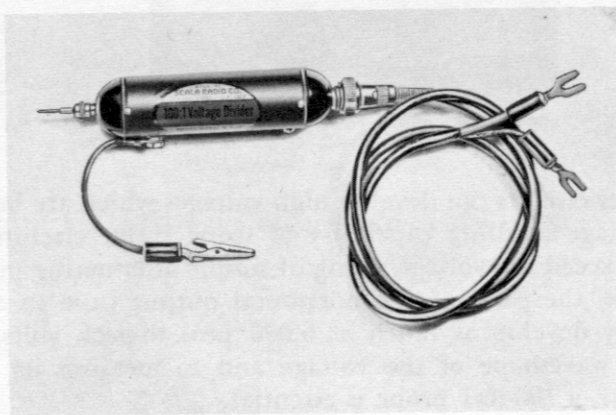

Fig. 601. Photo of a high-voltage, capacitance-divider probe.

probe is made as high as possible and depends, of course, on the frequency. In order to withstand the high voltages encountered in TV test work, the first capacitor (C1) in the probe network can be a high-voltage rectifier tube, such as a 1X2-A. The plate-to-filament capacitance of these tubes ranges from 0.85 to 1.5 μf . Thus, the input impedance of the probe at the fundamental frequency of the flyback pulse (15,750 cycles) is approximately 6 megohms and approximately 0.6 megohm at the 10th harmonic. Since the probe impedance (even at the 10th harmonic) is still much higher than the internal impedance of the circuit under test, the flyback pulse is reproduced essentially without distortion. The circuit of a 100-to-1 probe is shown in Fig. 604.

In addition to being able to withstand applied voltages up to 12 or 15 kv, this capacitor must have a physical shape that will not encourage corona discharge in the probe head.

A trimmer capacitor (C2) is provided so that the capacitance

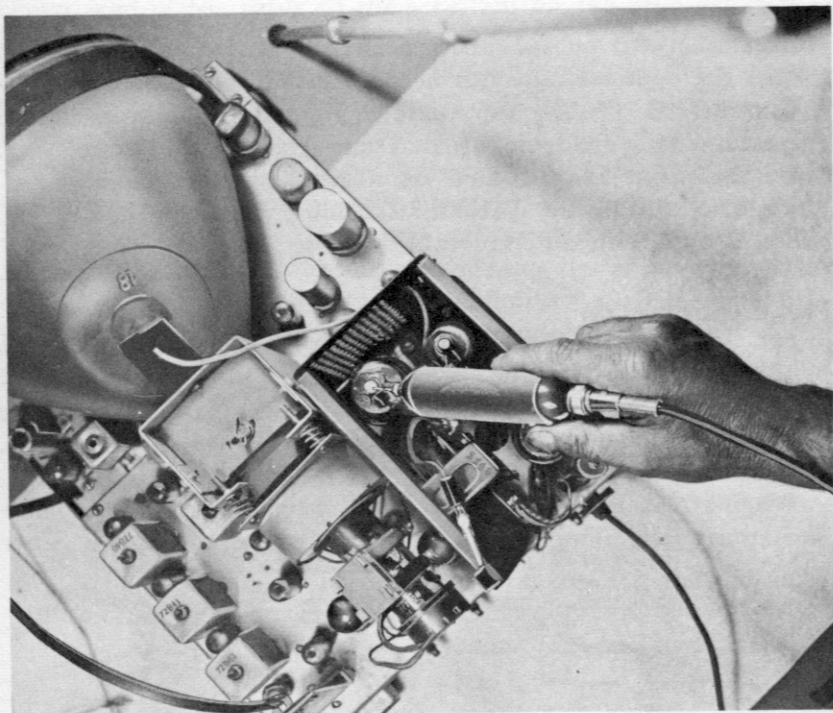

Fig. 602. Photo shows capacitance-divider probe being used to check high voltage waveforms.

ratio $C2/C1$ can be adjusted to exactly 100-to-1. This attenuation factor makes it easy to measure peak-to-peak voltages. Once the scope has been calibrated for a given peak-to-peak deflection

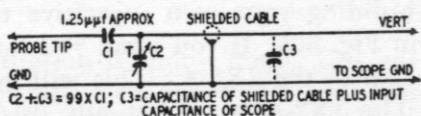

Fig. 603. Circuit of a high-voltage capacitance-divider probe. $C1$ can be the plate-filament capacitance of a 1X2-A high-voltage rectifier. Trimmer capacitor $C2$ is adjusted for a 100-to-1 voltage ratio with a given cable and scope.

sensitivity, it is necessary only to multiply the scope reading by 100.

The calibrating trimmer capacitor is mounted in the probe head and does not have to be a high-voltage type. With a 100-to-1 ratio the calibrating capacitor need withstand only 1% of

the signal voltage applied to the probe tip. The highest a.c. voltage likely to be encountered in TV work is about 15,000, so that the trimmer capacitor need withstand only 150 volts.

Commercial probes are shielded to avoid hand-capacitance effects and stray-field pickup that may confuse the scope trace. Since the probe is calibrated for a given shielded-cable capacitance, the calibrating capacitor C2 must be readjusted if the probe is used with different cables and scopes.

Probe construction

For TV servicing, two high-voltage probes are needed. One of these, the resistive type, is used only for the measurement of high d.c. voltages. (It is described later in this chapter.) The other high-voltage probe, often called the 100-to-1 divider probe, is for testing high-voltage pulses.

When constructing a probe of the latter type, both the cable and input capacitance of the scope must be considered, since

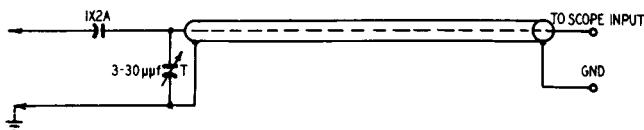

Fig. 604. Practical circuit arrangement of a high-voltage capacitance-divider probe.

these form part of the capacitance-divider network. For an attenuation of 100-to-1, C2 must be adjusted so that

$$C2 + C_s + C_c = 99C1$$

A design for building your own capacitive type high-voltage probe is shown in Fig. 605. If you wish, you can solder a probe pin to the plate cap of the 1X2-A. This will help in testing in crowded spots. The 1X2-A is not actually used as a tube, but rather as a capacitor, taking advantage of the interelectrode capacitance between filament and plate. The tube has a rating of 18,000 volts maximum, this being far in excess of normal pulse voltages found in TV sets. The 1X2-A corresponds to C1 in Fig. 603.

To build the unit, connect either of the filament pins of the tube to one terminal of a ceramic trimmer capacitor having a range of 7-45 μf. It isn't necessary to use a tube socket since you can solder directly to the filament pin. Now strip one end of a 2-foot length of coaxial cable, such as RG59U. Connect the

center lead of the cable to the terminal on the trimmer that is connected to the filament pin of the 1X2-A. The shield braid of the cable should be wired to the other side of the trimmer. Cover the tube with Scotch tape and coat the tape with coil dope or Duco cement.

Before the cement or dope has dried, insert the assembly into polystyrene (plastic) tubing. The cement will form a strong bond between the inside of the plastic tubing and the 1X2-A. Drill a hole in the plastic tubing so that it faces the adjustment screw of the ceramic trimmer. The hole should be large enough to pass a small screwdriver or an alignment tool.

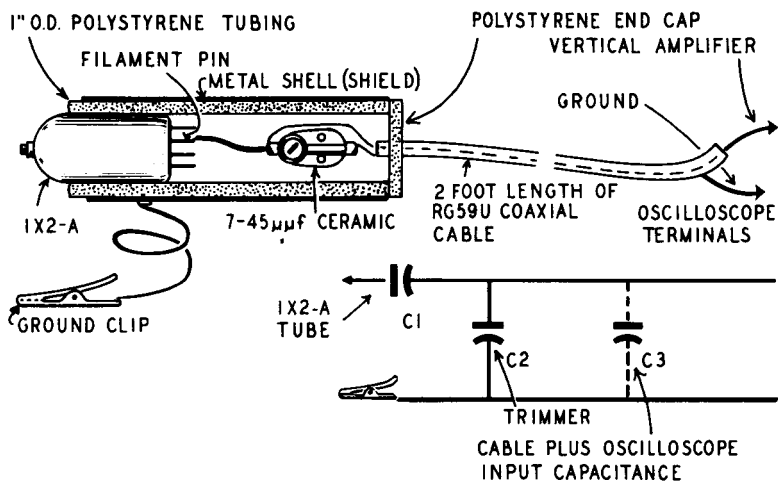

Fig. 605. Design for building your own high-voltage capacitance-divider probe. The 1X2-A corresponds to C1 in the circuit diagram.

At this stage, the job is almost done. Cut out a small circular piece of plastic having a diameter of 1 inch. Drill a hole in the center to allow clearance of the coaxial cable. Now place a metal shell over the probe unit. Run a connecting wire from the shield braid of the coaxial cable to the metal shell. If the shell is made of copper, you will be able to solder directly to it. If the shell is aluminum, you will have quite a bit of difficulty in making a soldered connection. Instead, drill a hole and mount a soldering terminal, using a 6-32 machine screw. A ground clip must also be attached, as shown in the illustration. The circular end cap, previously prepared, can now be fastened in place with Duco cement or coil dope.

How the probe works

To understand how the probe operates, first consider the simple resistive network shown in Fig. 606. Here we have two resistors in series placed across a 100-volt source. The voltage drops across each resistor will be determined by the amount of resistance. The total resistance in the circuit is 100 ohms and consists of two series resistors, 1 ohm and 99 ohms. The voltage (100) of the source distributes itself proportionately between the two

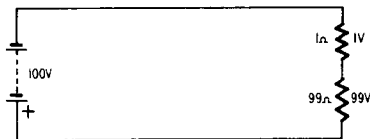

Fig. 606. Simple resistive network illustrates probe action.

resistors. Thus, we have 1 volt across the 1-ohm resistor and 99 volts across the 99-ohm resistor.

Now examine Fig. 607. The only difference between the circuit in Fig. 607 and that of the previous illustration is that in one instance we have series resistors and in the other series capacitors. The voltage-divider action, however, is the same in both cases.

In Fig. 607, C_1 represents the interelectrode capacitance of our 1X2-A. The tube manual quotes this capacitance as being $1 \mu\text{f}$. In series with this we have our trimmer capacitor (C_2). Shunting

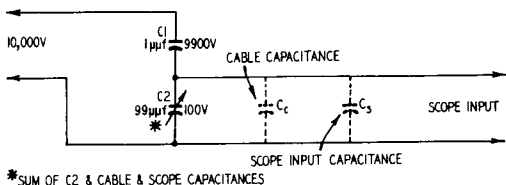

Fig. 607. Circuit showing voltage divider action of probe.

the trimmer is the capacitance (C_c) of the coaxial cable plus the input capacitance (C_s) of the scope. Trimmer C_2 must be adjusted so that the total capacitance (C_2 plus cable capacitance plus the scope input capacitance) is $99 \mu\text{f}$. This is best illustrated by the simple network of Fig. 608.

Capacitors C_1 and C_2 will now act as a voltage divider for a.c. pulses in the same way in which the resistors acted as a voltage divider for d.c. There is one important difference however. The reactance of a capacitor, expressed in ohms, is inversely propor-

tional to its capacitance. All this means is that C1 will have 99 times as much reactance, in ohms, as C2. If we put this network across a source of 10,000 volts, then we will get a 9,900-volt drop across C1 and a 100-volt drop across C2, as shown in Fig. 607. However, C2 is right at the input to our scope. This means that whatever voltage we measure on the screen of the scope must be multiplied by 100 to give us a true estimate of it.

Which divider probe?

A 100-to-1 high-voltage, capacitance-divider can give much more accurate results than a 10-to-1 capacitance-divider probe in many circuits where the technician ordinarily uses a 10-to-1 type. It is much better, for example, for checking the waveform and peak-to-peak voltage at the plate of the damper tube or at

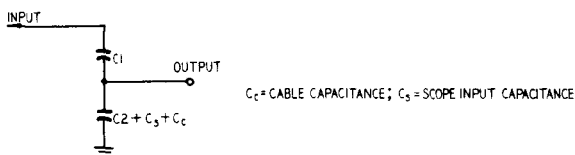

Fig. 608. Arrangement of various capacitances in the probe.

the plate of the horizontal oscillator. The input impedance of the 100-to-1 probe is higher than the input impedance of the 10-to-1 probe. Hence, it imposes less loading on the circuit. On the other hand, it may be impossible to get usable vertical deflection in low-level circuits with the 100-to-1 probe.

Most typical service scopes have a vertical deflection sensitivity of approximately .02 volt r.m.s. per inch at full gain, corresponding to a sensitivity of .057 volt peak-to-peak per inch. (Sine wave r.m.s. $\times 2.83 =$ peak-to-peak voltage; $.02 \times 2.83 = .0566$ or .057 approximately.) Under these conditions the 100-to-1 probe will provide 1 inch of deflection with an input signal of 5.7 volts peak-to-peak. If the signal voltage is less than this, the 10-to-1 probe will probably have to be used.

Although it is possible to provide an individual shielded output cable for each probe, the present trend is to provide a single universal shielded input cable which may be used with any one of an entire kit of probes.

How to check probe attenuation factor

Most TV service scopes are provided with a decimal step attenuator. To check the calibration factor of the capacitance-

divider, high-voltage probe, the scope is first applied across a low-impedance circuit such as the cathode of the damper tube, using direct leads. The step attenuator is set to the X1 position and the vernier attenuator is adjusted for any convenient number of squares of deflection on the screen. The probe is then connected to the scope and the step attenuator advanced to the X100 position. If the attenuation factor of the probe is correct, the waveform will then occupy the same number of squares on the scope screen as before. If it does not occupy the same number of squares, it can be adjusted by varying the trimmer capacitor. The shaft trimmer should be slotted to permit screwdriver adjustment.

Use of 100-to-1 probe with miscellaneous cables

Like the 10-to-1 probe, the 100-to-1 probe cannot be properly used with any cable other than the standard cable supplied with the probe. The reason for this precaution is that the attenuation factor of the probe depends to a large extent upon the capacitance of the connecting cable. Miscellaneous cables will not have the required value of capacitance. If it is desired to use a cable other than that supplied, the service technician should check the attenuation factor of the probe by the method outlined in the foregoing paragraph.

Use of probe with uncompensated scope

Some service scopes do not have a compensated input system. The input capacitance of such a scope will vary as the attenuator is varied, hence the calibration factor of the 100-to-1 probe will be changed somewhat. Further, it is very likely that waveform distortion will be encountered at the lower settings of such an attenuator due to frequency discrimination and phase shift in the attenuator itself. For these reasons, the use of the 100-to-1 probe with an uncompensated scope is not recommended.

Behavior of probe in 60-cycle circuits

At 60 cycles the 100-to-1 probe will not have a correct attenuation factor and waveforms will be severely distorted. At 60 cycles the capacitance of the probe head is effectively working into a constant resistance. The reactance of the probe head is not constant, but inversely proportional to frequency. In conse-

quence, each harmonic component of the waveform undergoes a different attenuation. As an example of this limitation, application of the probe is restricted to the horizontal sweep circuits. This is not a serious limitation since high a.c. voltages (beyond the capability of the 10-to-1 probe) are encountered only in the horizontal circuits. The 10-to-1 probe (See Chapter 5) is adequate to accommodate the operating voltages encountered in vertical sweep circuits.

Using the high-voltage probe

When alternate light- and dark-gray vertical bars appear at the left side of the raster, it may be difficult to tell at a glance whether this effect results from ripple in the high-voltage supply or from some other cause. But with a high-voltage, capacitance-divider probe the technician can see the high-voltage ripple on his scope screen and measure its peak-to-peak voltage. He is then in a position to discuss matters in practical terms.

Similarly, when there are slight but rapid fluctuations in picture brightness, you may suspect intermittent leakage in a high-voltage filter capacitor. Of course, a substitution test will answer the question, but you can save time and trouble with a capacitance-divider probe and scope. In the case of an intermittent leak in a high-voltage filter capacitor, the a.c. ripple across the capacitor will jump substantially during the brightness fluctuations. This test is more accurate than using a v.t.v.m. and high-voltage d.c. probe, because the pointer response of a v.t.v.m. is very sluggish compared with the inertialess response of the electron beam in the cathode-ray tube. These rapid voltage variations are almost completely smoothed out by the mechanical inertia of the meter movement in the v.t.v.m., but they are reproduced faithfully on the scope screen when you use a capacitance-divider probe.

A high-voltage, capacitance-divider probe is almost an absolute necessity for checking the shape and peak-to-peak value of the voltage waveform at the plate of the horizontal output tube. This is a key test point in cases of sweep-circuit trouble, and the alert technician usually starts his trouble shooting here. We cannot hook the scope directly to the plate of the horizontal output tube. The high a.c. voltage at this point would promptly burn out the scope input circuit; the blocking capacitor in the average scope is rated at only 600 volts.

We cannot use a low-capacitance 10-to-1 probe at the plate of the horizontal output tube because the 6,000 to 7,500 volts peak-

to-peak at this point would invariably flash across the probe network, which is not rated for this type of testing. Some technicians make a practice of using a gimmick for this purpose or merely holding the tip of a 10-to-1 low-capacitance probe *near* the insulated lead to the plate of the horizontal output tube.* Although these expedients will show the a.c.-voltage waveform on the scope screen, they are worthless for checking peak-to-peak voltage. And in most cases we must know the exact value of this voltage to get a true picture of conditions in the circuit.

Another highly questionable expedient in making these tests is to use a high-voltage d.c. probe (actually intended for use

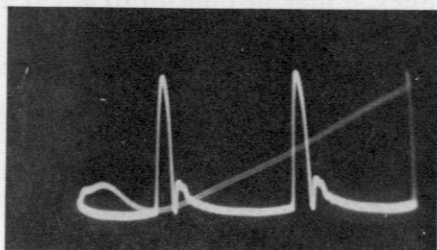

Fig. 609. Normal sweep waveform at the plate of horizontal-output tube, seen with the aid of a 100-to-1 capacitance-divider probe. Diagonal line is scope retrace. Peaks are about 6,000 volts high.

with a v.t.v.m.) with the scope. This is even less satisfactory than a 10-to-1 low capacitance probe, because the unshielded multiplier resistor in the high-voltage d.c. probe is highly susceptible to hand-capacitance effects and 60-cycle stray fields. Besides, the scope pattern changes with the slightest movement of the probe.

The only satisfactory and safe method of working with these high voltages is to use a properly designed, high-voltage, 100-to-1 probe.

Spotting flyback defects

A typical normal waveform at the plate of the horizontal output tube is shown in Fig. 609. The shape of the wave helps the technician identify certain defects in the flyback transformer, and the peak-to-peak voltage shows the condition of the drive circuit.

For example, a large negative undershoot in the waveform (Fig. 610) indicates excessive reactance between the primary and secondary windings of the transformer. This undershoot may

*See also adapter described on page 95.

cause Barkhausen oscillations, which show up as one or two vertical black lines at the left side of the picture.

If the transformer has other defects, the undershoot may be followed by a large voltage ripple. This will modulate the intensity of the beam in the picture tube, especially if the receiver has no high-voltage filter network. This form of intensity modulation appears as a series of light- and dark-gray vertical bars starting at the left side of the raster and becoming weaker toward the center. The same screen symptoms can arise also from several other causes, so the scope check of the horizontal output waveform saves valuable time by eliminating certain sources of trouble.

Checking high-voltage circuits

High voltage can do harm in these ways: It may *overload* the scope amplifier and distort the displayed waveform, without doing

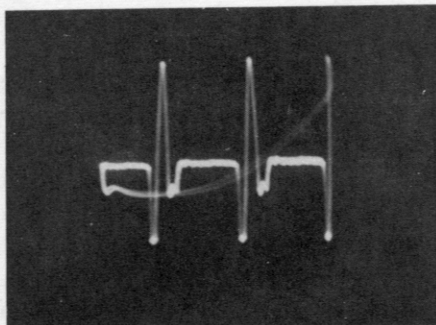

Fig. 610. *Negative pulse in sweep-output waveform indicates excessive leakage reactance in flyback transformer, may also generate Barkhausen oscillations.*

actual physical damage to the scope. It may puncture blocking capacitors and char or burn out attenuator resistors. It may arc through insulating washers and carbonize terminal strips.

The plate of the horizontal output tube represents a typical circuit point that is potentially dangerous to the scope input system.

Ripple in output of high-voltage supply

The 100-to-1 probe can be used for measurement of the peak-to-peak voltage in the ripple waveform of the d.c. high-voltage supply output, provided a high-voltage filter capacitor is connected in series with the probe to block the d.c. voltage component, as shown in Fig. 611. This test procedure is very useful

when tracing 60-cycle tunable buzz which varies in intensity with the setting of the brightness control. To eliminate high-voltage buzz, additional filtering should be used from the second anode of the picture tube to ground, or better shielding should be provided for the audio section of the receiver. In a test of this type, the operator must clearly distinguish between the display seen when the scope is set on 60-cycle sweep and that seen on 15.75-kc sweep. The *ripple* from the power supply is the display obtained on 15.75-kc sweep. The *buzz* voltage is the display obtained on 60-cycle sweep.

Many TV receiver circuits carry mixed waveforms of this nature and trouble shooting can be extremely puzzling to the beginner for this reason. As another example in point, consider the display of the horizontal sync pulse as obtained at the control grid of the picture tube. Two horizontal bars are seen in the background at the blanking level and at the maximum supersync level, plus vague and less well defined tracery. This interference in the display is caused by the fact that the vertical sync and equalizing pulses are mixed with the horizontal sync pulse. It is interesting to note that a phasable 60-cycle blanking voltage can be utilized to obtain a clean display in such cases by blanking out the interference component. Detailed consideration of such matters, however, is beyond the scope of this book.

High-voltage buzz

Experienced technicians have found many additional uses for the high-voltage, capacitance-divider probe. One of these uses is checking the output of the high-voltage filter system for regulation buzz. This should not be confused with sync buzz. Regulation buzz is caused by the limited current output capability of most flyback and pulse-operated high-voltage systems—especially those that have voltage-doubler circuits. Since the picture-tube beam current is cut off for approximately 1,100 μ sec (60 times a second) by the vertical blanking pulse, it follows that the output voltage from the unloaded high-voltage supply will rise several hundred volts for the duration of the blanking pulse and will then drop several hundred volts when the pulse ends and unblanks the screen. If the audio circuits and picture tube are adequately shielded, and if there are no serious faults in the audio system or FM sound detector, this regulation buzz is ordinarily below the threshold of audibility.

Behavior of probe in high-voltage rectifier section

The 100-to-1 probe is not suitable for use at the plate of the high-voltage rectifier tube because gas currents will develop in the probe head which will impair the calibration factor of the probe and may also cause damage to the scope input circuit. To test the high-voltage rectifier, use a high-voltage d.c. probe (described later in this chapter) and measure the d.c. voltage output at the filament of the tube.

Sweep circuits

The high-voltage, capacitance-divider probe is very useful for trouble shooting horizontal sweep circuits. It can be applied, for example, at the plate of the horizontal output tube or at the plate of the damper tube to check the operating waveforms and

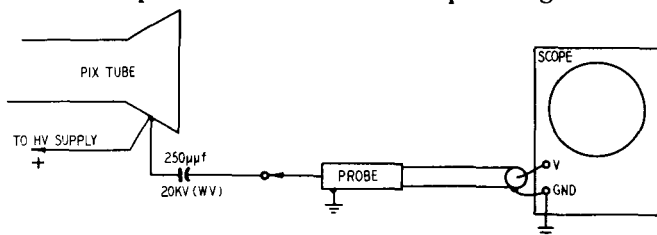

Fig. 611. Use of probe with high-voltage capacitor to block d.c. voltage.

to measure their peak-to-peak voltages without impairing the waveshape or incurring danger of damage to the scope.

When used in these applications the scope should first be calibrated for a known sensitivity in peak-to-peak volts per square. The probe is then connected to the scope and the calibrating factor is multiplied by 100. For example, if the scope has been calibrated for a sensitivity of 10 peak-to-peak volts per square, the probe converts this calibrating factor to 1,000 peak-to-peak volts per square and a 6,000-peak-to-peak-volt waveform will occupy 6 squares on the scope screen.

The operator should note that the peak-to-peak voltages of such waveforms are specified in the service notes for the receiver with a tolerance of 20%. This means that the receiver operation is judged to be faulty if a 6,000-peak-to-peak-volt wave measures more than 7,200 or less than 4,800 peak-to-peak volts. It must be observed in this regard that variations in power-line voltage are reflected through the receiver circuits as variations in measured peak-to-peak voltages. Receiver manufacturers specify waveform voltages upon the basis of a design center line of 117 r.m.s. volts.

Sync circuits

A TV station signal is almost always used in tracing sync circuit troubles, except in some very difficult cases where no signal at all can get through. The low-capacitance, high-impedance, 10-to-1 voltage-divider probe is the most useful type for working in these circuits since it is least likely to disturb circuit conditions through its loading effect.

Waveforms in sync and sweep circuits are characterized not only by their *shapes*, but also by their *peak-to-peak* amplitudes.

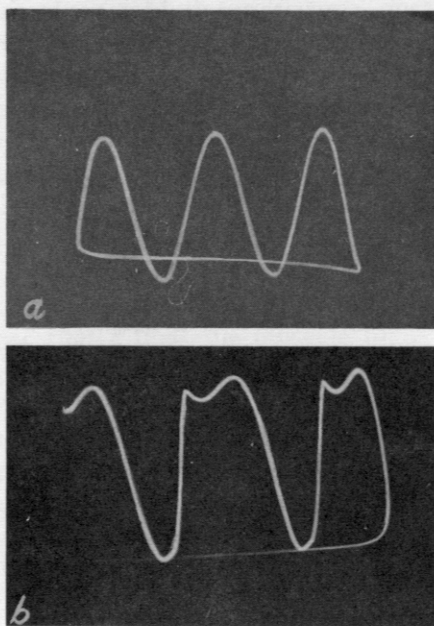

Fig. 612-a, b. (a) Normal oscillator waveform in a Synchrolock-type horizontal-sweep circuit. (b) Distorted waveform indicates circuit defects. For maximum accuracy in identifying circuit troubles, waveforms in this section of a TV receiver should always be picked off with a capacitance divider probe.

Both these characteristics are generally given by the manufacturer in the service data for the receiver. Look for trouble in any circuit where the measured voltage is more than 20% off the specified value.

Of course, even if the peak-to-peak voltage is correct, waveform distortion as shown in Fig. 612 and Fig. 613 indicates trouble. Obviously, this type of trouble shooting cannot be done properly

unless the technician has the necessary reference data as well as the right probe at hand. Fig. 612-a shows the normal oscillator waveform in a Synchrolock type horizontal sweep circuit. The distorted wave in Fig. 612-b indicates circuit defects. For maxi-

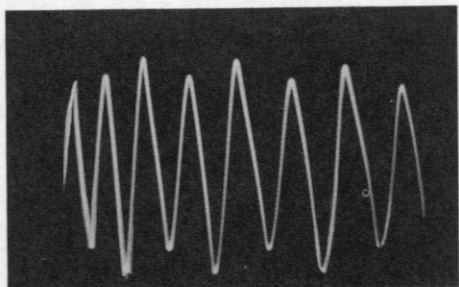

Fig. 613. *The voltage of successive peaks is not the same. This symptom is caused by the presence of a spurious low-frequency voltage in the circuit under test.*

mum accuracy in identifying circuit troubles, waveforms in this section of a TV receiver should always be picked off with a *low-capacitance* probe.

In the sweep and high-voltage circuits the receiver generally supplies its own signal for test. This may not always be true, especially in some types of horizontal-sweep circuits. For example, where the horizontal oscillator gets its plate voltage from the B plus boost line, it may be a question of "which came first—the

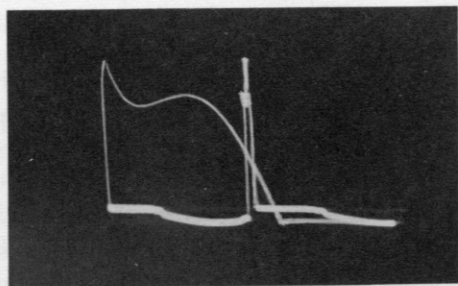

Fig. 614. *Normal 6-kv flyback pulse at plate of horizontal-output amplifier. The capacitance-divider probe attenuates the pulse by a factor of 100 to 1 to avoid damaging the scope input circuit.*

chicken or the egg?" If the oscillator fails, there will be no B plus boost; if the B plus boost circuit fails, the oscillator won't work. In these cases you can save yourself lots of time and aggravation with an auxiliary power supply.

We have deliberately re-introduced at this point, the subject of the 10-to-1 divider probe (previously discussed in Chapter 5) to emphasize the need for *two* probes when working in the sweep section. One of these should be a 10-to-1 probe and the other, a 100-to-1. Some horizontal sweep voltages are high enough to damage the scope input circuit unless a *high-voltage capacitance-divider* probe is used. If you make a mistake and use a crystal probe or a low-capacitance probe at this point, you can say goodby to the probe and the scope input circuit. A breakdown here may even burn out the flyback.

A typical high-voltage waveform is shown in Fig. 614. Like the sync and other sweep waveforms, these kickback waves should

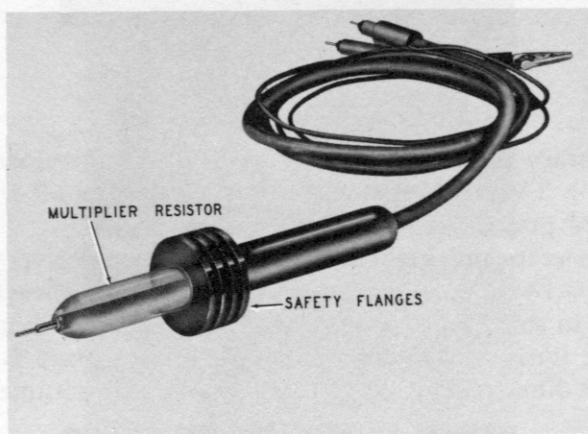

Fig. 615. Photo of typical high-voltage probe. Safety flanges present a long barrier to high voltage.

have the shapes and peak-to-peak amplitudes specified by the manufacturer.

Grounding requirements are less severe with low-capacitance, 10-to-1 probes—in fact, with this type of probe the ground connection may sometimes be omitted—but a *high-voltage probe must always be grounded!* Unless the ground lead on the probe is clipped to the receiver chassis or B minus line, the whole test system will be hot and you may get a severe and possibly dangerous shock. Remember, even before stepup in the flyback transformer, there is a 3,000- to 6,000-volt pulse at the plate of the horizontal output tube.

Throughout this text we have pointed out the importance of grounds and the precautions necessary when working with high-voltage horizontal circuits. We wish to stress that the lower

B plus voltages are equally or even more dangerous. *Shock from B plus or from line voltages can prove fatal.*

High-voltage multiplier probe

When you speak of high voltage in a TV receiver you can mean either pulse type voltages of the kind that appear at the

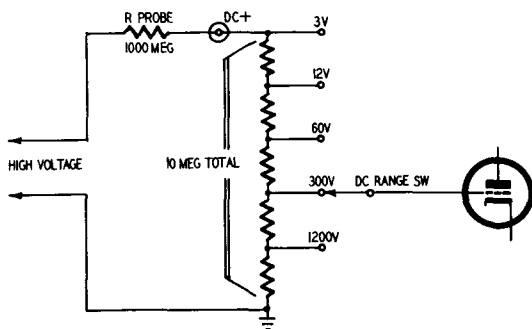

Fig. 616. *The high-voltage probe becomes part of the voltage divider network at the input to the v.t.v.m.*

plate cap of a horizontal output tube or you may refer to the d.c. voltage appearing at the second anode of the picture tube. We have already seen how high pulse voltages can be measured. To test high d.c. potentials, up to about 30,000 volts, a special high-voltage multiplier probe is needed. Circuit-wise, the probe resembles the isolation probe (described in Chapter 7). All that it contains is a resistor which acts as a voltage divider. However, the simplicity of its circuit does not give a clue to the physical construction of the probe. A photo of this giant of the probe family is shown in Fig. 615.

The resistor (or resistors in series) in a high-voltage probe are especially constructed to eliminate or minimize the possibility of voltage breakdown. These resistors are usually spiral-wound of metallic or carbon-film ribbon and are encased in a plastic having a high dielectric. They quite often have values as high as several hundred megohms and are manufactured to withstand the effects of changes in temperature and humidity.

The high-voltage probe can be considered as a true voltage divider, in the same classification as other voltage-divider probes. In Fig. 616 we see how the resistance in the high-voltage probe is in series with the resistive input network of a v.t.v.m. Assume, for example, that the resistance in the high-voltage probe is 99

times that of the divider network. Assume also that we are measuring 1,000 volts. Of this, 990 volts will appear across the resistor in the high-voltage probe and 10 volts will be across the voltage-divider network in the v.t.v.m. You will now have a d.c. scale reading on the v.t.v.m. of 10 volts. This, multiplied by 100, will tell you the correct amount of d.c. voltage at the point of test.

Multiplication factor of probe

Resistive-type high-voltage probes are identified by their multiplying factor. Thus, a particular commercial probe might have a multiplying factor of 30. This means that when using such a probe the d.c. volts scale on the v.t.v.m. must be multiplied by this amount. For example, if you have the high-voltage test prod touching the filament of the high-voltage rectifier tube (a high-voltage point) and your v.t.v.m. reads 500 when set on the 1,000-volt scale, then the high d.c. voltage output of your TV receiver is 15,000 volts ($30 \times 500 = 15,000$).

The amount of multiplication will depend upon the value of the multiplier resistor in the probe head and also upon the test instrument itself. Values of probe multiplier resistors vary from 480 megohms to as much as 1,320 megohms or more. Many manufacturers supply high-voltage probes designed for their particular instruments. When you buy this type of probe, make sure you get one that will give correct results when used with your test equipment. Not all probes have the same multiplication factor. This varies from as low as 15 to as high as 100. The most common types used in TV repair work have multiplication factors of 10, 15, 30 and 100.

Calculating probe resistance

If you have a v.t.v.m. or a sensitive instrument such as a 20,000-ohms-per-volt (or higher) multitester, you can easily calculate the amount of resistance that should be in the high-voltage probe. Before you start, however, there are a few things you should know. You must first decide what multiplying factor you want and you also need to know the input resistance of your particular v.t.v.m. The input resistance of a v.t.v.m. usually includes the value of resistance in the isolation probe. For example, if a certain v.t.v.m. is said to have an input resistance of 11 megohms, 1 megohm is in the isolation probe used with that v.t.v.m. and 10 megohms

is in the resistance divider input of the instrument itself.

To find the value of a high-voltage probe resistance, use this very simple formula:

$$R_{\text{probe}} = M (R_{\text{input}}) - (R_{\text{input}} - R_{\text{cable}})$$

R_{probe} This is what we are looking for. It represents the amount of resistance in the high-voltage probe.

M This is the multiplying factor. If you want to have a probe such that you will multiply your v.t.v.m. meter scale by 10, then M is 10. Similarly, if you want a multiplication factor of 100, then M is 100.

R_{input} This is the input resistance of your instrument. If you have a v.t.v.m., this information can be supplied by the manufacturer. The input resistance of a v.t.v.m. includes the resistance of the isolation probe used with it. If you have a 20,000-ohms-per-volt meter, you can calculate the input resistance by multiplying the full-scale reading of the meter in volts by its ohms-per-volt value. For example, if you intend using your 20,000-ohms-per-volt meter on the 1,000-volt scale, then its input resistance is $20,000 \times 1,000$ or 20,000,000 ohms (20 megohms).

R_{cable} This is the value of resistance in the isolation probe.

Suppose now that we had a multimeter with a sensitivity of 20,000 ohms per volt and we wanted to buy or build a high-voltage probe. Suppose also that our instrument had a 5,000-volt scale and that we wanted to have a multiplying factor of 10 so that we could use this scale to read up to 50,000 volts.

$$R_{\text{probe}} = M (R_{\text{input}}) - (R_{\text{input}} - R_{\text{cable}})$$

$$R_{\text{probe}} = 10 (5,000 \times 20,000) - (5,000 \times 20,000 - 0)$$

$$R_{\text{probe}} = 900,000,000 \text{ ohms or } 900 \text{ megohms}$$

In this particular illustrative problem we did not have to consider the resistance of the isolation probe since we calculated the input resistance of the test instrument without it. Note also that our probe is properly calculated only for use with the 5,000-volt scale of the meter.

We can use the same technique for working out a problem involving a v.t.v.m. Assume that we have a v.t.v.m. with an input resistance of 10 megohms and that we have an isolating resistor in the d.c. probe of 1 megohm. We want a scale factor of 100 times so so that we can use the high-voltage probe to read 30,000 volts on the 300-volt scale of the v.t.v.m.

$$R_{\text{probe}} = M (R_{\text{input}}) - (R_{\text{input}} - R_{\text{cable}})$$

$$R_{\text{probe}} = 100 (11,000,000) - (11,000,000 - 1,000,000)$$

$$R_{\text{probe}} = 1,090,000,000 \text{ ohms or } 1,090 \text{ megohms}$$

If we had ignored the 1-megohm resistance of the isolation probe, our answer would have come out to 1,089 megohms. This would have been close enough for us to identify the kind of probe to buy.

Note the difference between a high-voltage probe when used with a multimeter (such as a 20,000-ohms-per-volt meter) and a v.t.v.m. The input resistance of a multimeter (volt-ohm-milliammeter) depends upon which voltage scale you use. This means that your high-voltage probe can be used with only one scale of the multimeter. You must decide, before you build or buy the probe, just which scale you intend using. The input resistance of a v.t.v.m., however, is the same for all scales, hence you can set the v.t.v.m. multiplier switch to any desired position.

Using the high-voltage multiplier probe

There are only a few places in a TV set where such a probe can be used, yet these are of such importance and such frequent causes of TV failure that having such a probe is convenient and necessary.

Modern television power supplies for picture tubes are characterized by high voltage, low current. The current produced by such high-voltage supplies is actually the scanning-beam current of the picture tube and is usually less than 1 ma. The high-voltage, low-current feature of such supplies means that they are high-impedance points and as such must be measured by high-impedance test equipment. Measuring a voltage is equivalent to putting the test instrument in parallel with the circuit under test. In order not to disturb the circuit being measured, the testing device must draw a minimum amount of current from the circuit.

High-voltage multiplier probes are used in conjunction with v.t.v.m.'s or multitesters having a sensitivity of 20,000 or more ohms per volt. Most v.t.v.m.'s can read up to 1,000 volts d.c., a range that can easily be extended with high-voltage multiplier probes. These probes cannot be used with ordinary 1,000-ohms-per-volt multitesters since such instruments require 1 ma for full-scale deflection, an amount of current that would seriously overload TV high-voltage supply circuits.

To use the probe, connect the probe cable to the v.t.v.m., setting the instrument on the desired high-voltage d.c. scale. Connect the negative lead of the v.t.v.m. and also the ground lead of the probe to the TV chassis. When working with a transformerless type TV set, use an isolation transformer, or else make sure that neither the exposed TV chassis nor the test instrument can possibly touch any ground connection. A ground could be a piece of conduit, bx cable or a metal strap running along a table and into a wall. Grounds pop up in the most surprising places.

The high-voltage probe, plus a bit of deductive reasoning, can give you considerable information about a TV set. If, for example, a picture tube does not have enough brightness, the fault could be in the high-voltage supply or it could be a defective picture tube. A quick check with the multiplier probe at the second anode of the picture tube will put suspicion where it belongs. If the high-voltage at the anode point is adequate, then you need not worry about the horizontal output transformer or high-voltage rectifier tube. The trouble lies in the picture tube or picture-tube circuit.

If you get a high-voltage reading at the filament of the high-voltage rectifier tube, but none at the second anode of the picture tube, then the high-voltage filter resistor is open. Of course, with this condition there would be no brightness on the screen.

When using your high-voltage multiplier probe, you will get a more accurate reading of the high voltage if the brightness control is turned down until there is no picture or raster on the screen. TV high-voltage supplies have very poor regulation and the addition of a load, even as small as that of a probe and v.t.v.m., can cause a big voltage drop. With the picture-tube beam cut off, you can get a better idea of just how much voltage the power supply is developing. Once you've taken this reading, rotate the brightness control, but keep the probe at the same point. You will then have an idea of how much voltage exists during operation.

Safety precautions

High voltage is *dangerous*. Follow these common-sense precautions.

1. Keep your hands, shoes, bench and floor dry.
2. Dirt and moisture provide paths for high voltage. Keep the

plastic head of the probe and the protective flanges of the barrier clean *and* dry. You can clean the space between flanges with an air hose, pipe cleaners or handkerchief.

3. When making high-voltage checks, keep your fingers *behind* the barrier, toward the cable end of the probe. Don't let your fingers extend over the flanges of the barrier. The safety flanges are designed to present a long path to high voltage—eliminate danger from contact or corona. The correct way to use the probe is illustrated in Fig. 617.

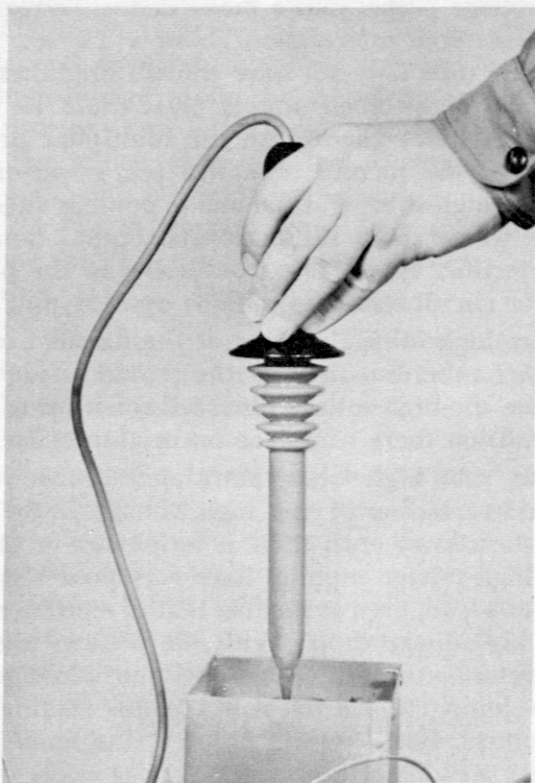

Fig. 617. *Correct technique for using a high-voltage probe.*

4. Connect the ground clip of the high-voltage probe to the negative side of the high-voltage supply. This is usually the chassis. Make this connection *before* starting high-voltage tests.
5. The safest place to make a high-voltage test is at the second-anode terminal of the picture tube. The reason for this is that there is usually a large-value filter resistor (470,000 ohms

or more) between the filament of the high-voltage rectifier tube and the picture-tube second anode. If you should accidentally touch the second-anode pin, the voltage drop across the filter resistor would give some measure of protection. The highest d.c. voltage point in *any* TV set is at the filament of the high-voltage rectifier tube. It is true that the voltage *across* the filament is about 1.25, but from *either* filament pin to chassis is maximum high voltage.

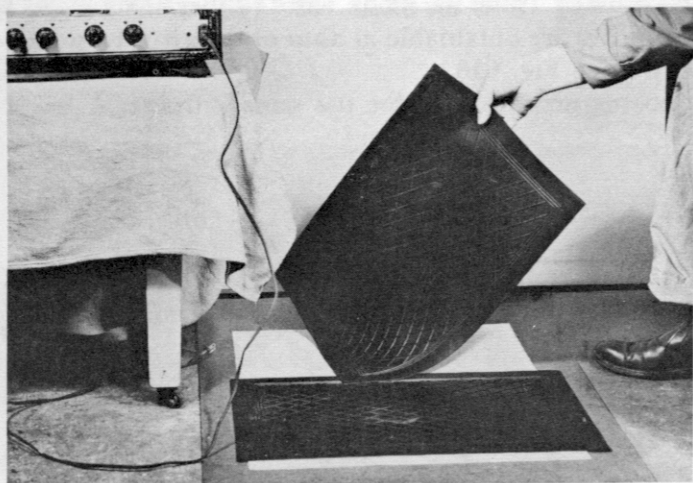

Fig. 618. A rubber mat is very inexpensive, high-voltage insurance.

6. You don't have to touch a high-voltage point to get a shock. All you have to do is to bring your hand close enough. High voltages can discharge from sharp points (corona). High voltage can crawl along a dust path or through ionized air. Keep one hand in your pocket.
7. Before doing any soldering or wiring in a high-voltage supply, make sure the set is off, and then discharge the high-voltage filter capacitor. A picture tube whose coating is being used as part of the high-voltage filter will discharge more slowly than a filter capacitor.
8. When measuring in the region of 30,000 volts or more, keep the probe at the high-voltage point until the meter needle moves up to its final reading. Do not keep the probe connected for an unnecessarily long time, since the probe resistor may heat, causing drift of the meter needle.

Remember, *it takes less than 150 ma to kill a normal, healthy human being.* A quick look at Ohm's law ($E=IR$) will show you

that very little voltage is required to push that current through your body if its resistance is low enough.

Keep your body resistance as high as possible, and avoid *any contact* with the live circuits of a receiver. At times, unfortunately, many of us forget the fact that the live circuits may include the chassis or *any grounded object (even the floor)*.

Every service shop should have a wooden floor. Where work must be done in homes or other locations with cement floors, insulate yourself from the floor with rubber mats. Mats about 13×21 inches are obtainable at auto or department stores—inexpensively. (See Fig. 618.)

Dry boards may be used for the same purpose. A few 1-inch-



Fig. 619. *The multiplier resistor in the probe is a barrier between you and the high voltage. Take care of it.*

thick boards about 10×60 inches will provide a safe working platform. They should be stood on end to dry when not in use.

Don't depend on the wire insulation to protect you if the internal multiplier resistor should break down or arc over.

High-voltage probes are easier to carry, store and keep dry, if they are taken apart. With the probe dismantled the multiplier resistor should be kept in a toothbrush container lined with soft, dry cloth. A small zipper bag is an ideal carrying case (Fig. 619).

The outside of the probe should always be wiped dry before and after use. Moisture inside the probe can be removed with a narrow bottle brush.

isolation and direct probes

Isolating probes are simple in their construction. The probe housing, usually made of plastic, contains a resistor placed in series with the probe tip and the coaxial cable connected to the output side of the probe.

Isolation probe for v.t.v.m.

Isolation probes are made for use with either a v.t.v.m. or a scope. Although the two probe types may seem identical, they are not interchangeable. The isolation probe for work with a v.t.v.m. usually contains a 1-megohm resistor as the isolation unit. The isolation probe for work with a scope uses a 47,000-ohm resistor.

Reasons for using isolation probe

This probe when used with a v.t.v.m. permits you to make measurements of d.c. voltages at test points which also contain a.c. Whenever you have a.c. in a circuit, particularly at high frequencies, it is important to remember that to the receiver an instrument is nothing more or less than a capacitor. Since test instruments shunt the circuit under test, the additional capacitance results in a lowering of the circuit impedance. Because a.c. voltage is proportional to the impedance, you can see that this has the effect of reducing the amount of voltage present—thus giving a false indication on the meter.

The series resistor in the isolation probe (as the name implies)

acts to isolate the capacitance of the test instrument from the circuit being examined. However, it does more than just that. The probe series resistance, plus the input capacitance of the v.t.v.m., acts as a resistance-capacitance filter. This helps keep a.c. out of the v.t.v.m. where it might be rectified and added to the d.c. voltage being measured, thus changing the accuracy of the reading.

Probe construction

The isolation probe (also known as a *d.c. probe*) for the v.t.v.m. contains a resistor placed inside a test prod as shown in Fig. 701. The 1-megohm resistor is placed as far forward in the probe

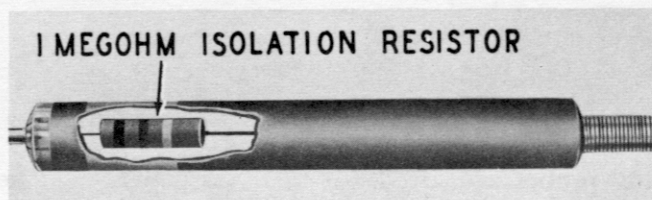

Fig. 701. Cut-away view of isolation probe for use with v.t.v.m.

as possible. This means that in using this probe you are always placing 1 megohm between your hands (and cable) and the set under test. This helps increase the effect of isolation.

When you buy v.t.v.m., you usually receive an isolation probe with it. Since the manufacturer considers the isolation probe an integral part of the v.t.v.m., the input resistance of the instrument includes the value of resistance in the probe. The input resistance of a v.t.v.m. is calculated from the isolation probe tip as a starting point and not from the input jack. A v.t.v.m. with an input resistance of 11 megohms has 10 megohms in the instrument and 1 megohm in the probe.

A representative isolation probe for use with a v.t.v.m. is shown in the exploded view (Fig. 702). This particular type does not connect directly to a cable, but instead slips on the probe end of a direct probe. A feature of this unit is that it contains a small slide switch which can be used to short the 1-megohm resistor contained in the probe housing. When the slide switch is pushed back, the 1-megohm isolating resistor is automatically connected in series with the probe tip. Moving the switch forward shorts the resistor and supplies a direct connection to the input of the v.t.v.m. In this position the probe can be used for measuring a.c. voltages or for making resistance checks. Thus, the

one unit serves both as a direct probe as well as an isolation probe.

Effect of probe on meter calibration

Although the isolation probe may seem to be a separate and distinct unit, it should be considered only as an extension arm of

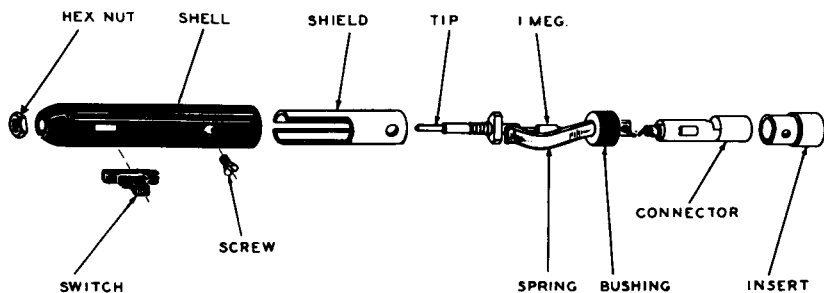

Fig. 702. Exploded view of isolation probe showing assembly details.

your v.t.v.m. and a definite part of that instrument. The isolation resistor in the probe is in series with the voltage-divider network in the input circuit of your v.t.v.m. and is part of the d.c. input resistance of the instrument. If you do not use your isolation probe, then you cannot be sure that your d.c. voltage reading is correct.

To see the effect of the isolation probe when used with a v.t.v.m. examine Fig. 703. Assume that we are measuring the B

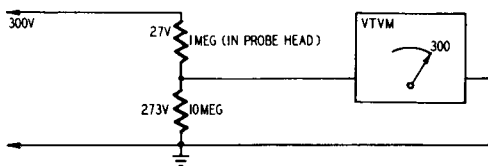

Fig. 703. The v.t.v.m. is calibrated for use with the isolation probe.

plus potential of a circuit and that we know the voltage to be 300. Approximately 27 volts will drop across the probe resistor, the balance (273 volts) appearing at the input to the v.t.v.m. Your test meter, however, will not read 273 volts. It will indicate 300 volts because it has been calibrated to do so. Suppose, now, that you measure the same 300-volt point, but this time use direct

test leads instead of the isolation probe. Your v.t.v.m. will now read 327 volts. Generally speaking, neglecting to use your isolation probe will cause your v.t.v.m. reading to be about 10% higher than the correct value.

Increased isolation

To secure greater isolation, some service technicians attach a high-value resistor of 1 or more megohms to the isolation probe, the free end of the resistor then serving as the probe point. There is nothing wrong with this idea, provided you realize that it will reduce your v.t.v.m. voltage reading.

As an example, suppose you connect a 9.1-megohm resistor to the probe tip. The total probe resistance now becomes 10 megohms approximately. If the internal resistance of your v.t.v.m. is also 10 megohms, then the voltage you are testing will divide itself equally between the meter and the probe. All you have to do then is to multiply your scale reading by 2. Because of the way in which your v.t.v.m. is calibrated, your voltage reading, though not absolutely correct, will be good enough for all practical purposes.

The advantage of this technique is that it reduces loading on circuits whose resistance is an appreciable amount. You might use this approach when testing in a circuit where the resistance is 1 megohm or more. Naturally, in circuits having a much lower resistance this isn't necessary.

You will find it convenient to mount the 9.1-megohm resistor on a small piece of bakelite or similar insulation material. Connect one end of the resistor to a tip and the other end to a female connector so that it can slide right on your isolation probe. If you make this device, keep it with your test equipment. It will save you time.

Using the probe with a multimeter

The isolation probe that you received with your v.t.v.m. or scope should not be used with a multimeter (volt-ohm-milliammeter) regardless of the sensitivity of the instrument. The input resistance of such instruments depends upon the setting of the voltage scale selector. Consider a multimeter having a sensitivity of 1,000 ohms per volt. This is a very widely used instrument for servicing work. The input resistance can be calculated by multiplying the sensitivity by the d.c. voltage scale you select. Assume,

for example, that you set the selector switch to read 5 volts. At this setting, the input resistance is 5,000 ohms ($5 \times 1,000 = 5,000$). In series with this will be our isolation probe with its 1-megohm resistor. If we put this combination across a source of 200 volts, then almost the entire 200 volts will drop across the 1-megohm probe resistor and less than 1 volt will appear at the input to the meter. Thus, for a voltage source of 200, your meter will give scarcely any indication.

Suppose that you use a multimeter having a sensitivity of 20,000 ohms per volt. On a 5-volt scale setting, the input resistance is 100,000 ohms ($5 \times 20,000 = 100,000$). Your meter would now read about 10% of the actual voltage under test. If we rotate the scale selector so that the multimeter is set to read 500 volts, then the input resistance becomes 10 megohms ($500 \times 20,000 = 10,000,000$). This would apparently seem to solve our problem since our multimeter, set to this scale, now has the same input resistance as the average v.t.v.m. There is still one serious difference, however. The v.t.v.m. has been calibrated for use with the isolation probe; the multimeter has not. Thus, the multimeter, set on the 500-volt scale will still read about 10% below normal.

Using the isolation probe

With few exceptions, you can use the isolation probe whenever you find it necessary to measure d.c. voltages. Keep in mind, however, that a test point in a radio or television receiver may also be a low-or high frequency signal point. For example, the plate of the horizontal output tube is usually operated at about 400 volts d.c. However, on this same plate you will find pulses having an amplitude up to about 6 kilovolts. Any attempts to measure d.c. voltage here using the isolation probe will result in damage to the probe and to the v.t.v.m.

Before you work on a TV set you should determine whether the point under test is low or high impedance and whether there are simultaneous d.c. and a.c. voltages. You should know also the approximate amplitudes of these potentials. A typical example is the control grid of the vertical blocking oscillator of a TV set. Here we would have a negative d.c. bias of about 30 volts, a pulse having an amplitude of some 85 volts and an impedance of 10 to 15 megohms.

Quite obviously, the a.c. voltage pulse can easily be measured by means of a calibrated scope and a capacitive divider probe of the type described in an earlier chapter. The impedance of the scope

and probe combination is sufficiently high so that the circuit is not disturbed.

Now consider the problem of measuring the d.c. bias voltage. This is low enough so that its measurement can easily be done. However, if you use a typical v.t.v.m. and isolation probe, the total impedance you will present to the vertical oscillator grid circuit will be 11 megohms. If, at the moment of test, the setting of the vertical hold control is such that the resistance to ground of the vertical oscillator grid circuit should also happen to be 11 megohms, the effect of testing would be to put these two resistances in parallel. In other words, the resistance of the grid circuit (11 megohms) would be in parallel with the resistance of the probe and v.t.v.m. (also 11 megohms). The total net effect would

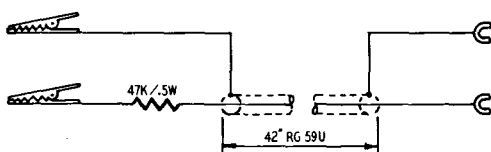

Fig. 704. Circuit of isolation probe for use with a scope. RG-62U has a smaller capacitance than the coaxial cable shown here.

be to cut the circuit resistance in half, reducing the bias voltage by a similar amount and producing a false reading on the meter.

There are several ways of meeting this situation. You can use a v.t.v.m. having a higher input resistance. Many v.t.v.m.'s are rated at 26 megohms (including the 1-megohm isolation probe). Using such an instrument would reduce the impedance of the vertical blocking oscillator grid circuit from 11 megohms to slightly less than 8 megohms. If our bias voltage was actually 30, the meter would show it to be only about 22.

Another alternative is to use your resistive type high-voltage d.c. probe. If, for example, you have a high-voltage probe with an attenuation factor of 30 (a common value), you can get an accurate oscillator bias voltage reading by setting your v.t.v.m. on the 3-volt scale. If the correct bias is 30 volts, the meter needle will move about one-third the way up on the scale. The reading will be fairly accurate because the resistance of the high-voltage probe is more than 100 times as great as the resistance of the vertical oscillator grid circuit.

Isolation probe for scope

The probe containing a 1-megohm isolation resistor and des-

cribed in the preceding paragraphs is for use with a v.t.v.m. Isolating probes are also designed to provide the optimum filter characteristic for a scope used in visual alignment work.

The circuit of a scope type isolation probe is shown in Fig. 704. The isolation resistor is a 47,000-ohm, $\frac{1}{2}$ -watt, 10% carbon resistor in series with the hot lead of a 42-inch length of RG59U coaxial cable. The connector at the scope end can be either as

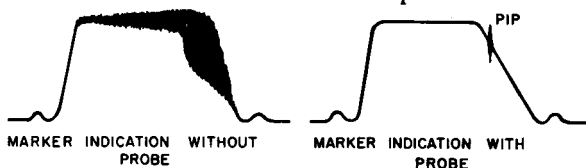

RESISTIVE ISOLATING PROBE SHARPENS MARKERS

Fig. 705. The use of an isolation probe sharpens the marker on the response curve.

shown in the illustration or a coaxial type, depending upon the kind of connector you have on your own scope.

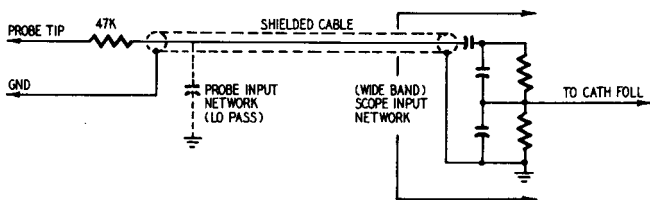

Fig. 706. Relationship of the isolation probe to the scope input.

Marker indication

The resistive isolation probe sharpens markers, the effect being illustrated in Fig. 705. The stray capacitance of the wiring inside the probe, plus the capacitance of the shielded cable, makes the probe act as a low-pass filter. This has the effect of sharpening broad marker pips and keeps these pips from masking or covering parts of the sweep waveform. The time constant of the isolating probe is also a matter of some importance. Too large a time constant causes distorted indication; too small a time constant develops a broad and indistinct marker.

The relationship of the probe to the scope input is shown in Fig. 706. In addition to filtering the high-frequency components from beat markers to yield a sharp marker on the scope screen, the probe is also used for testing at the converter grid or TV front

ends. In this connection, the isolation resistor suppresses any possible tendency toward oscillation, regeneration, or instability due to feedback.

The direct probe

The type of probe you should use in servicing depends entirely upon where in the set you need to direct your attention. Quite obviously, if all you intend doing is to make resistance checks, all you need are a pair of test leads. If you want to examine the waveform in i.f. stages, you need a crystal demodulator probe.

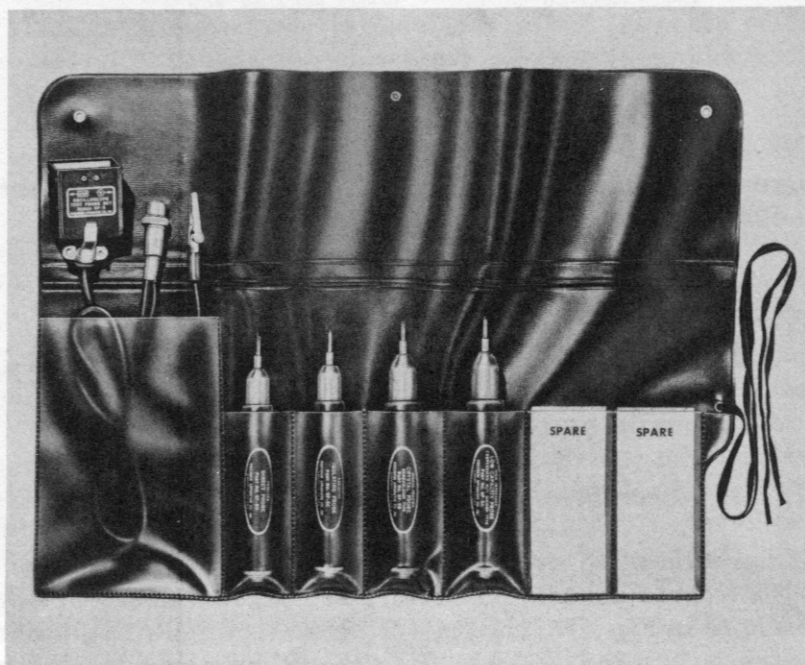

Fig. 707. Commercial test probe set for use with a scope. The probes are easily interchanged on the cable, facilitating rapid service work.

If you need to check low-impedance or low-frequency circuits or circuits where cable capacitance is not important, then you could use a shielded, direct probe.

Having probes on hand for your servicing work is very much like having screwdrivers. You can either have individual screwdrivers or you can get the type that comes with a handle, a chuck and five or six interchangeable blades. You can do the same with

probes. Either get individual probes for each purpose or get a test set with a universal cable which will accommodate each probe.

A test probe set for use with a scope is shown in Fig. 707. Here we have direct, isolating, crystal and low-capacitance (10-to-1)

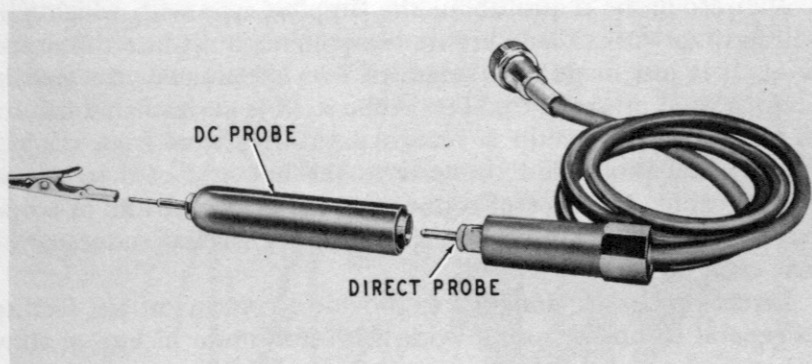

Fig. 708. The direct probe is part of the cable. The d.c. probe is the slide-on type. The alligator clip is used when a hold-on connection is wanted.

probes. The same cable is used for each of the four. To use any probe, the technician does not disconnect the cable from the scope but simply connects each probe head to the cable as required by a particular test.

A different system is shown in Fig. 708. In this illustration a direct probe is permanently attached to the cable and always

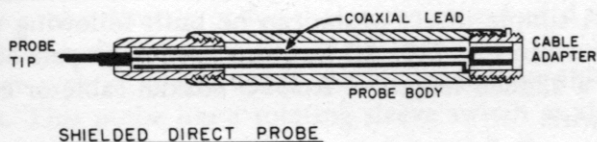

Fig. 709. Cross-sectional view of a shielded, direct probe.

forms part of the test setup. Additional probe heads, such as a d.c. probe, are designed to slip on the prod end of the direct probe. The principal advantages of the probes shown in Figs. 707 and 708 are the shielding of the inner conductor from probe tip to the connector and the fact that it is not necessary to change cables when using different types of probes.

A shielded direct probe is exactly what its name implies. It's a unit for making a connection between your v.t.v.m. or scope and the set being repaired. A cross-sectional view of a direct probe is shown in Fig. 709.

Direct test probes are used in low-frequency or low-impedance

circuits where direct connection to the test point is required in order to utilize maximum scope sensitivity and where the added input capacitance contributed by the coaxial cable is not important.

A direct probe is just about the simplest type with which you will have to work. There are no components built into the probe head. It is just made of a length of wire terminated in a needle point, a prod or probe tip. The probe itself is an insulated handle in which the probe tip is mounted. A wire runs from the tip through the probe and connects to the hot lead of a length of coaxial cable. The type of connector used at the v.t.v.m. or scope can be a phone tip, pin plug, spade lug, or coaxial connector or may even be bare wire.

Direct probes are designed to provide a convenient test facility in general trouble-shooting work, with minimum pickup of stray

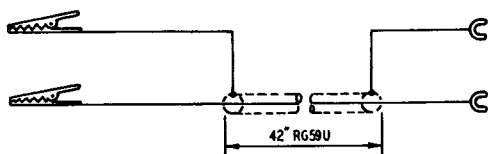

Fig. 710. A length of coaxial cable is easily converted into a direct probe.

fields in the vicinity of the chassis as well as with minimum circuit loading. A simple direct probe can be built following the information given in Fig. 710. All that you need are a pair of alligator clips and a 42-inch length of RG59U coaxial cable or equivalent shielded wire.

Open test leads used in trouble-shooting work often lead to false conclusions because of the introduction of stray voltages into the scope pattern. The difference between waveforms obtained with a direct probe and those secured with open test leads is shown in Fig. 711. The input cable used with the direct probe should be of a type that will add minimum capacitance to the scope input circuit, since the input capacitance tends to shunt the circuit under test and impairs its high-frequency response.

Combined direct and isolation probe

The probe shown in Fig. 712 can be used either as a direct or as an isolation probe for a scope, merely by flipping a switch. When the switch is closed, the 47,000-ohm resistor is shorted and

the probe can then be used for general trouble-shooting work. With the switch opened, the 47,000-ohm resistor is put in series with the hot lead of the coaxial cable. The resistive circuit is basically that of a low-pass filter which will not only sharpen alignment markers, but will also clean noisy response curves. The entire probe must be shielded so that stray fields will not be picked up. The resistor is a noninductive type.

Combined direct and isolation probes can also be used with the v.t.v.m. The photo (Fig. 713), shows a probe of this type. The setting of the slide switch mounted in the probe housing permits

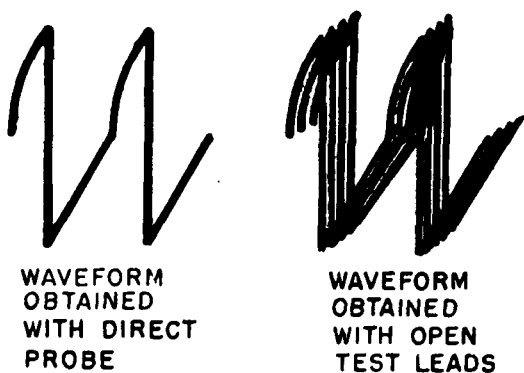

Fig. 711. As shown in the illustration above, a direct probe helps avoid pickup of stray fields.

using the probe directly or for the measurement of d.c. voltages. A 1-megohm resistor is used in this probe.

Another type of combined probe has a slightly different construction. This probe has a rotating sleeve switch at the pointed

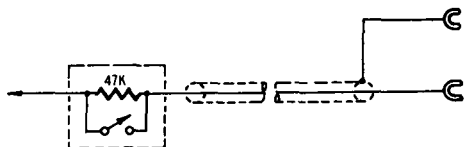

Fig. 712. Simple set-up of combined direct-isolation probe. When the switch is up you have an isolation probe. With the switch closed, the resistor is shorted, and you then have a direct probe.

end. The rotating sleeve is set to *DCV* when making d.c. voltage measurements, or it can be turned to the *OHMS* position for making resistance checks. When the sleeve switch is set for the measurement of d.c. voltages, a 1-megohm resistor becomes part

of the probe circuit. When the probe head is turned, the resistor becomes shorted and the unit acts as a direct probe.

The switching feature is convenient and desirable since it helps you avoid changing probes when you have to make different types of measurements. This is particularly true when you are making quick checks and do not wish to take the time to look for or change probes. Just one word of caution: When you use a switch type probe (combined isolation and direct probe), your v.t.v.m. function selector switch must be set accordingly. If you have your combined probe set for use as an isolation probe, the v.t.v.m. function selector should be set to read d.c. volts and the range selector should be turned to give you the scale reading wanted.

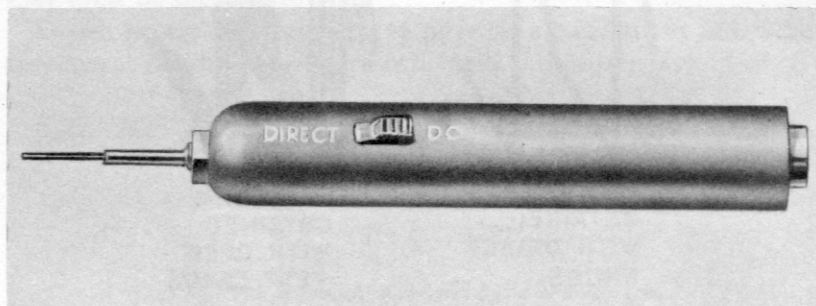

Fig. 713. Photo of commercial type direct-isolation probe. The circuit is the same as that shown in Fig. 712.

If you use the combined probe as a direct probe, then turn the function selector on the v.t.v.m. to the ohms position.

Before touching the probe point to any terminal in the receiver, (when the receiver is turned on) make sure that both your combined probe and your v.t.v.m. are properly set. Failure to make this check can result in damaged test equipment. Look at the settings on your instrument first, then make your tests.

Test leads

A pair of test leads can be considered as a probe, particularly since it performs the basic function of any probe—that of connecting the test equipment to the receiver being repaired. The use of test leads is satisfactory for simple checks such as resistance measurements but, for r.f., i.f., video or audio servicing, ordinary test leads can produce serious errors, misleading conclusions and loss of valuable servicing time.

It is particularly important not to use ordinary leads in critical circuit points such as TV front ends or i.f. stages. Their use often produces a feedback loop between the receiver, test instrument and power line. The resulting regenerative feedback can trigger the amplifier of the receiver into oscillation. On the other hand, the high resistance of the isolation probe interferes with this feedback loop and isolates the circuit under test from the v.t.v.m. or scope.

Sometimes, to avoid loss of signal in a probe, a direct connection to a test point is necessary. Using unshielded leads can often obscure the pattern obtained on the scope. This is particularly true if the test signal is weak; you are then operating your scope at its highest sensitivity (vertical gain and sensitivity controls at maximum settings). Under these conditions an unshielded test lead can easily pick up stray, unwanted signals which are then promptly built up in the scope's vertical amplifier. Use a shielded lead to avoid such effect. Shielding a test lead will add about 55 μmf to the input capacitance of the scope, hence the restriction on the use of shielded leads to low-impedance or low-frequency circuits.

Handling probes

Your probes (and this applies to any and all types you have on your bench) are the eyes and ears of your test instruments. Your probes represent the one and only way in which you can properly connect your test instruments to the radio and TV sets you repair. Obviously, the same care you extend to your v.t.v.m. and scope should apply to your probes.

Of all probes, quite possibly test leads are the most abused. Next in line of neglect are coaxial cables. The shield braid on such cable, if allowed to become frayed, can short to the center conductor, giving false short indications, sometimes causing real damage in radio and TV circuits.

To protect test leads, cables, probes, mount a rack near your service bench. Some service technicians use a towel rack (about 18 inches long) to keep test leads handy, clean, and unsnarled. Fasteners that are sold in hardware stores for holding broom and dust-mop handles make excellent, inexpensive clips for keeping probes handy and out of your way when not in use. Having probes on your bench that are not in use is inviting trouble. It's quite

easy to accidentally put a TV set down on a probe. Keep your probe out of your tool box. A probe is a test instrument and not a tool. However, you will at times find it necessary to take one or more probes with you for servicing in the home. Protect the probe by means of a tool roll. If possible, keep the probe in a separate compartment.

When buying coaxial cable keep the capacitance in mind. RG59U (21 μf per foot) is widely used, but RG62U (only 13.5 μf per foot) is gaining favor. RG59U has an impedance of 73 ohms while RG62U is 93 ohms.

specialized probes

Although probes used in radio and TV servicing have many different names, most of them fall within a few categories. This would include such units as demodulator probes, divider and high-voltage probes. However, there are numerous types which have a special application and as such do not fit into any regular classification. Included in this group we would have the audio-tracer, hum, capacitor tester, frequency-compensated and a.f., r.f. tracer probes, magic-eye probes, etc.

Audio-tracer probe

This probe permits tracing audio signals at any point beyond the sound detector stage in AM, FM and TV sets. As you can see

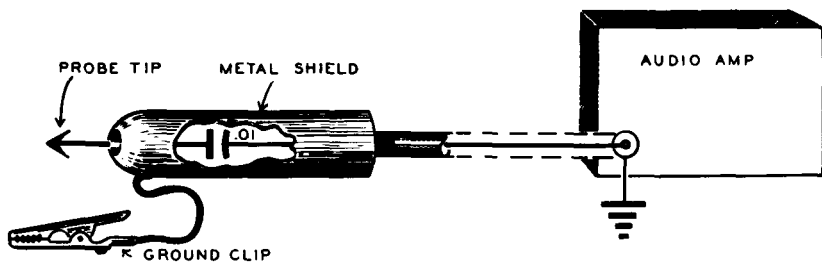

Fig. 801. Simple audio tracer probe checks signal at any point after the detector. Value of capacitor in probe is not critical.

from the illustration (Fig. 801) it is simply a .01- μ f capacitor in series with a shielded cable.

The output of the probe can be put into a pair of earphones, v.t.v.m. or scope. A modulated r.f. signal, fed into the front end of the receiver, will result in a steady audio signal at the input to the measuring instrument. If you depend on a radio or TV station for a signal source, the varying audio voltage will cause the v.t.v.m. needle to swing or will show as a changing waveform on the face of the scope tube. The audio-tracer probe is often used in conjunction with a simple audio amplifier. You do not even require a separate audio amplifier for this purpose. Just connect the output leads of the audio probe to the center and either end terminal of the volume control of any receiver in good working order.

Using the probe

In trouble shooting, start at the output of the audio detector and work your way toward the voice coil of the speaker. A dead or weak stage or one that is not working properly can be found very easily. If, for example, you have a good signal at the control grid of one of the audio amplifier tubes but no signal when the probe point is put on the plate pin, that particular tube circuit is dead. If you have the same amount of signal, or less, at the plate than you have at the control grid, then the tube may be weak. If the signal is clear and undistorted at the input to a tube but has hum or distortion when the probe pin is at the plate, then trouble exists in that circuit.

Use the probe to check coupling capacitors. If the signal exists on the plate side of the coupling capacitor but you hear no signal on the other side (control grid of the following tube), then the capacitor may be open or the grid circuit may be shorted. You can check for intermittent coupling capacitors in the same way. Put the probe pin on the control grid connected to the coupling capacitor. Wiggle the capacitor gently or tap it with an alignment tool. If the sound breaks, the capacitor is intermittent.

The capacitor in the probe blocks d.c., allowing the audio signal through. You can place the probe at any point that has audio signal or audio plus d.c. voltage. For best results the capacitor should be a mica type and should be rated for at least 600 working volts d.c. The value of capacitance is not critical. Any unit, .01 μf or greater, can be used. The probe housing should be of metal to avoid pickup of stray fields. An insulated length of shielded wire should be connected to the probe head. Connect the shielded braid of the wire to the metal housing of the probe.

The center conductor of the shielded wire or cable connects to one side of the capacitor inside the probe. The other side of the capacitor is connected to the probe tip. The probe tip and the capacitor must be carefully insulated from the metal housing or the shield braid of the cable. Fasten a wire to the front end of the probe and solder an alligator clip to the other end of this wire. This will be the ground connection of the probe.

Hum probe

Finding hum or tracing hum to its source can easily be one of your most exasperating experiences when working with radio, audio or TV. The probe shown in Fig. 802 is very useful for locating hum in all types of receivers or audio systems.

Jumble wind as many turns as you can conveniently get on a

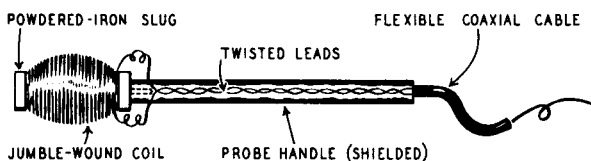

Fig. 802. This probe is very useful for tracking down sources of hum. Use any small diameter, insulated wire for the coil.

powdered-iron slug. The slug can be any spare you may have salvaged from an old i.f. transformer or r.f. coil. When you finish winding, cover the coil with rubber tape. Any size of wire can be used. The type of insulation on the wire is not important. However, the more turns of wire you get on the slug, the greater will be the sensitivity of the unit, hence small diameter wire is preferable. Bring the two ends of the coil through a probe handle about 12 inches long. The probe handle can be bakelite or plastic tubing, but it should be covered with metal shield braid. Connect the coil leads to flexible coaxial cable. Put a connector at the end of the cable suitable for connecting to the vertical input of your scope.

Using the hum probe

Connect the leads of the probe to the vertical input of the scope. One lead (either one) should go to the vertical and the other lead to the ground post. Set the vertical gain and vertical sensitivity controls to maximum. Pick up the probe handle (near

the cable end) and then examine the scope screen. If the horizontal line on the screen seems wavy, turn down the vertical gain slowly until the line is straight. Now put your fist around the probe coil. Your scope should show a rather large but distorted, sine wave. This is 60-cycle hum pickup.

The probe is now ready for action. You can touch it to a chassis to determine the amount of hum voltage at a particular point, examine magnetic fields around transformers and chokes as well as determine the effectiveness of shielding. The probe coil will not be harmed if you touch the slug (protruding from the coil) directly to the chassis or any metal-cased transformer or choke.

Capacitor-tester probe

A probe of special design and construction is available to help the service technician locate open and intermittently open capaci-

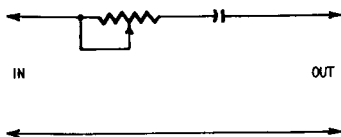

Fig. 803. Circuit diagram of capacitor-tester probe.

tors. To prevent the temporary healing of intermittent capacitors when they are checked, this probe includes a variable resistor which is operated by the probe tip.

A circuit diagram of the probe is shown in Fig. 803. In Fig. 804 we have a cross-sectional view showing mechanical construction details. The needle point of the probe is spring-loaded, the amount of resistance present in the probe depending upon the pressure you place on the probe needle point. When the probe is touched very lightly to a test point, the probe has maximum resistance. With a small amount of pressure the probe point is pushed back into the body of the probe, reducing the resistance. A portion of the inside of the probe is coated with graphite and is the resistance element. This resistance is made variable by means of a sliding contact which is connected to the probe needle. As the sliding contact is pushed toward the rear end of the probe (by pressure placed on the probe needle point), the amount of resistance in the probe unit decreases to a minimum.

The probe is used with the radio or TV set turned on and actually in an intermittent condition. This is important, since

intermittent capacitors often will heal temporarily when a radio or TV set is turned off for testing and then back on again. This temporary healing is serious problem for the service technician, since the capacitor becomes almost impossible to locate and yet must be replaced if callbacks are to be kept to a minimum.

This probe makes a positive test. Normal operation of the radio is restored when the defective capacitor is tested. The set gradually goes back into the intermittent condition as pressure on the probe is reduced. Tests can be made rapidly. No adjustments or capacitance settings are needed. It is not necessary to unsolder capacitors for testing.

How capacitor-tester probe works

When an intermittent capacitor is tested with this probe, temporary healing of the intermittent is prevented by the high initial

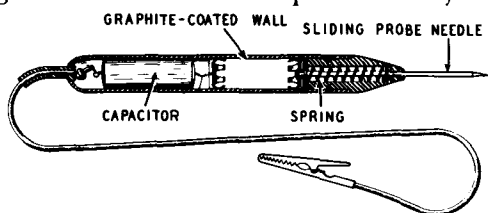

Fig. 804. Cross-sectional view of capacitor-tester probe.

resistance in the probe unit. This allows the test capacitor in the probe to charge slowly, preventing a heavy current flow and voltage drop. As the probe tip is pressed, the resistance gradually drops to zero and the probe then becomes a substitution tester. The resistance automatically returns to maximum for the next test when the probe is removed.

Sometimes, in servicing, a known good capacitor is used to shunt a suspected defective unit. An uncharged capacitor is almost like a short circuit, and the instantaneous current can be very high in a circuit where the potential is as low as 200 volts d.c. This large current has a welding effect on paper capacitors. Since such capacitors tend to become intermittent at or near the points where the foil connect to the leads, the current, by its welding action, produces a temporary cure. Thus, the disadvantage in testing with a substitution capacitor is the healing effect of the sudden, heavy current flow in the intermittent capacitor caused by the charging of the test capacitor at the instant it is

applied. This charging surge also causes a sharp voltage drop and a disturbance that can travel all through the circuit the capacitor is in and to other sections of the radio or TV set where it can temporarily heal any capacitor that is intermittent.

Servicing with capacitor-tester probe

Turn on the radio or TV set and note the abnormal operation, such as the whistle caused by an open bypass capacitor. Allow the set to operate until it stops or else goes into the intermittent condition. Localize the defective stage or section by using a typical signal-tracing technique.

Having found the defective stage, connect the test probe across each of the capacitors in turn. Do this by attaching the clip to

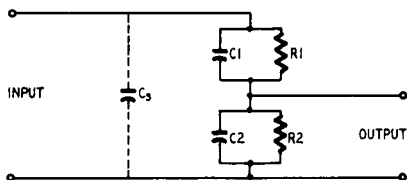

Fig. 805. *Electrical arrangement of the frequency-compensated probe.*

the ground or outside foil side of the capacitor and then pressing the probe tip against the terminal to which the other lead of the capacitor is soldered. Try not to move the capacitor under test. Avoid applying the probe directly to the leads of an intermittent which seems to be sensitive to the slightest movement or vibration. If possible, trace back a distance on the other leads going to the same terminals as the capacitor and apply the probe at these points. If a capacitor is soldered to a terminal of a wafer tube socket, apply the probe to the corresponding tube pin extending under the socket. This will prevent moving the capacitor as it is tested.

The capacitance of the test capacitor within the probe (.05 μf , 600 working volts d.c.) is an ideal value for substitution testing across practically all bypass and coupling capacitors. Do not use it on capacitors working above 600 volts, such as buffer capacitors of auto radios, shorted capacitors or low-value units which are part of tuned circuits (these are usually mica or ceramic types which seldom give the intermittent trouble experienced with paper capacitors.)

The important point to remember in repairing intermittents

is to avoid heating any capacitor which might be intermittent, until it is positively located.

Frequency-compensated probe

One of the most common specialized probes is the frequency-compensated type (Fig. 805) used to prevent distortion of TV signals tapped off high-impedance points and fed to the input of a scope. The unit consists of two parallel-connected R-C networks in series across the signal source with the output signal tapped off at the junction of the R-C networks. Distortion is minimum when R_1C_1 equals R_2C_2 .

The tip and body of the probe are shielded to minimize pickup of hum and stray signal voltages. Although the shield is designed

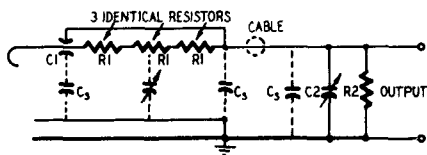

Fig. 806. Circuit diagram of the frequency-compensated probe.

for optimum performance, it adds to the stray input capacitance C_s and brings the total value to 10–15 μf . This capacitance greatly attenuates the signal (20 db or higher) and often is high enough to detune high-impedance circuits or distort video-frequency signals. When a capacitance type probe is used with a wide-band low-gain scope, the technician must be constantly aware of the amount of attenuation and possible distortion in his instrument.

The circuit arrangement of a frequency-compensated probe is shown in Fig. 806. The high input capacitance, usually caused by the probe shield, is reduced by using C_1 as the shield around the hot input lead. This results in the greatest portion of stray capacitance C_s being shunted in parallel with the cable capacitance. The body of the probe houses R_1 —three 1.5-megohm resistors in series—shunted by a small gimmick capacitor. The output voltage of the probe is developed across R_2 .

Probe amplifier

A wide-band video amplifier is used to compensate for the high attenuation in the probe (40 db). The amplifier circuit, shown

in Fig.807, has enough amplification to overcome the losses in the probe, so that the over-all gain, from probe input to amplifier output, is 1. In other words, your scope will then see a signal of the same amplitude as that presented to the probe tip. The low output impedance of the video amplifier prevents signal distortion that normally occurs when the scope has a high input impedance shunted by high cable capacitance.

The unit has a built-in selector for attenuating the input signal by 10 and 100 to prevent possible overloading of the video amplifiers. The scope is usually operated at maximum gain with the attenuator in the wide-band amplifier set for the lowest output that gives adequate vertical deflection. Thus any possible circuit overloading will occur in the scope where it will be more readily recognized and can be corrected by reducing the scope's gain.

The portions of the compensating circuit equivalent to C2-R2 (in Figs. 805 and 806) are a part of the attenuator. The input stage is a 6U8 with its pentode section connected as a shunt-peaked video amplifier and its triode section as a direct-coupled cathode follower. The second stage is a 6AH6 with shunt peaking in its plate circuit. A 1-megohm variable resistor in the grid circuit is the low-frequency compensation adjustment. The output stage is a 12BY7 cathode follower with an 80-ohm output impedance. B plus voltages are regulated by a 3-tube voltage-regulator circuit using a 12B4 series regulator, 12AX7 control tube and a 5651 voltage-regulator tube to supply the reference voltage. The heaters of the 6U8 and 6AH6 are supplied with d.c. voltages developed by a 1-amp bridge rectifier across the heater winding of the transformer.

Specifications for the probe and amplifier are: over-all gain, X1, X0.1, and X0.01; bandwidth, 5 cycles to 12mc \pm 3 db; input impedance, 4.5 megohms; input capacitance, 1.5–2 μ f; maximum input voltage, 150 a.c., 600 d.c.; undistorted output, 4.5 volts maximum.

A.f. and r.f. tracer probe

Here is a compact and useful tracer that can be constructed for less than \$5. It may be carried in your pocket or in a small toolbox. The circuit diagram appears in Fig. 808 and its construction is shown in Fig. 809.

Fig. 807. The frequency-compensated probe is used in conjunction with a wide-band video amplifier. The amplifier compensates for the high attenuation of the probe.

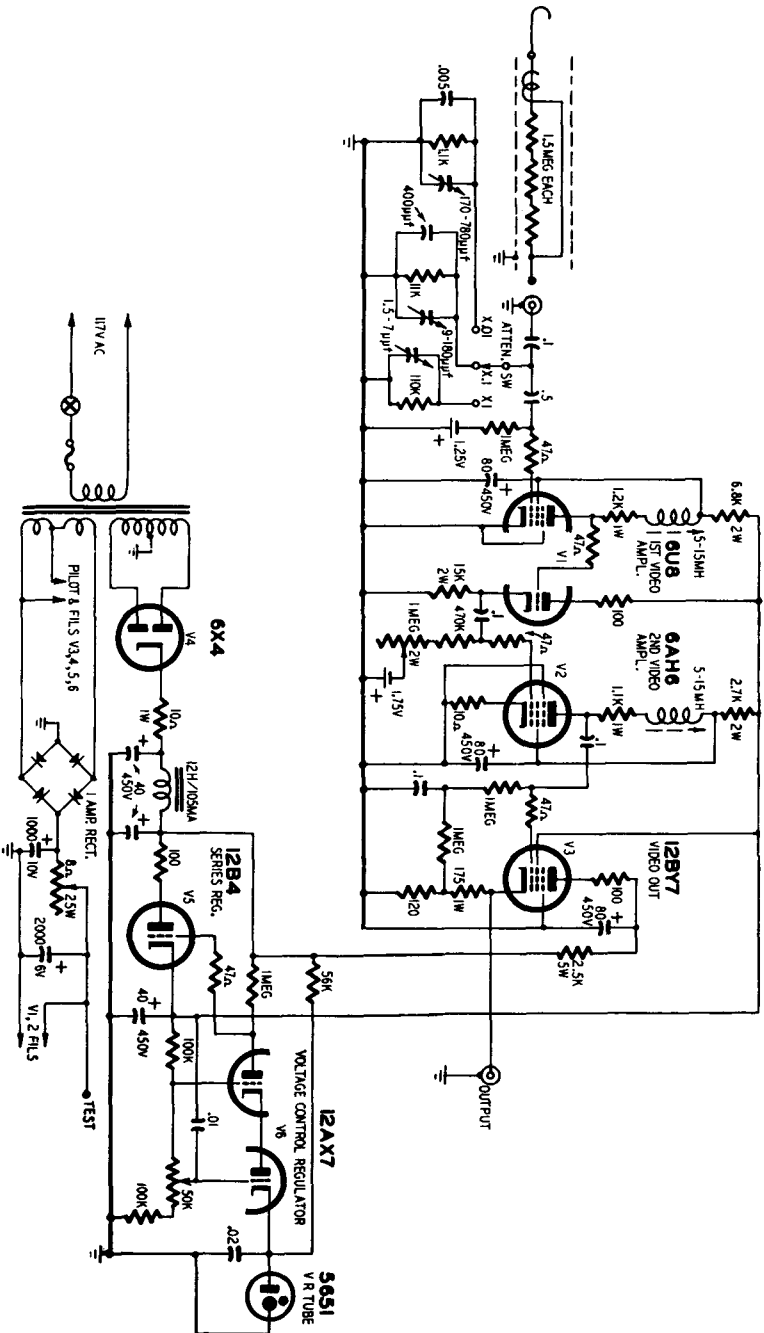

This unit works on either a.f. or r.f. When in use on a.f., the reactance of the r.f. choke is negligible, so R1 becomes the load. With r.f. applied, the choke becomes the load, with R1 being bypassed, as shown in the schematic. A 1N34 or a 1N66 germanium diode can be used as a detector.

A plastic cigarette case houses the unit. Assemble all the components, except the test probes, outside of the case, using just their own leads for support. Then bring the probe and ground leads through the top cover of the case, and solder them in place. Now slide the assembled unit into the case, and bring the jack out through the hole at the bottom. You can make these holes

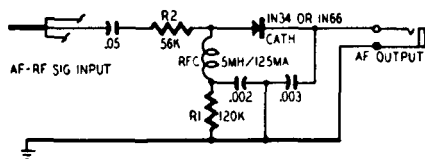

Fig. 808. Schematic diagram of the compact a.f.-r.f. tracer probe.

with ease using the heated tip of a large nail. Have the openings on the top cover large enough to allow sliding the cover off along the wires for possible repairs.

Using the probe

To use, connect the ground clip to the ground side of the receiver, or the chassis on a.c.-d.c. sets. Plug in a pair of high-impedance phones or feed the probe's output into an audio amplifier. With the receiver tuned to a local station, start at the antenna and pick up the r.f. signal. Then move on to the r.f. amplifier tube (if any) or the i.f. convertor. Touch the grid lug and then the plate lug. Do this to each tube in the following order: the i.f. amplifier, second detector, a.f. amplifier, and the power amplifier (output tube). Never apply the probe to the rectifier tube!

Whenever the signal is not heard, you will know that the trouble is in that particular section of the receiver. If the signal is traced from the antenna to the output tube without losing it, check the speaker transformer for a defective winding.

The probe will not show the exact nature of the trouble, but will narrow it down for easier servicing. Then you can use your meter in that particular section for locating the defective tube or part.

The components used in the tracer probe are not critical in value, but they should approximate those shown in the schematic. Since the probe will be applied to the plates of tubes the .05- μ f blocking capacitor should have a voltage rating of about 600.

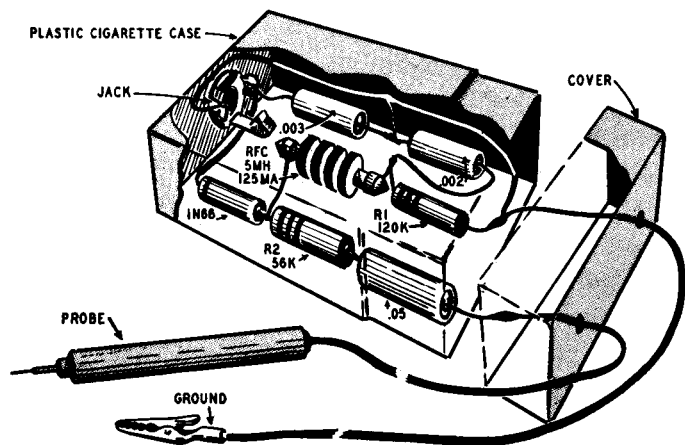

Fig. 809. Physical layout of the components in the a.f.-r.f. tracer probe. Parts placement is not critical.

This is especially true when the probe is used to trace the horizontal and vertical sweep voltages in a television receiver. In some sets the boost voltage is used as the plate supply of the vertical and horizontal circuits, and it often exceeds 500 volts.

When servicing TV sets be careful not to touch the probe to any point having pulse voltages higher than 500 volts peak.

Miniature test probes

In this book we have been primarily concerned with probes used for radio and television servicing. However, electronics is by no means confined to repair work, many technicians finding employment in such varied enterprises as hearing aids, radar, development and research in laboratories, electronic production in factories, manufacture and maintenance of computing devices, etc. Regardless of the type of work, wherever test instruments are used you will find the need for probes. While such probes are made to fit specific testing problems, the information given in this book should enable you to use such probes with a greater degree of understanding.

As examples of such specialized probes, consider the two types of miniature test probes recently devised at the National Bureau of Standards. These probes were designed to speed development and testing in the NBS radar miniaturization laboratory. Light and compact, the probes are designed to cling to the test point without danger of contacting adjacent leads. Intended particularly for use with miniaturized electronic equipment, the probes offer possible advantages for use with conventional-sized devices as well.

The two probes are illustrated in Fig. 810. The probe shown at the bottom of the picture is a push-on type with a very small

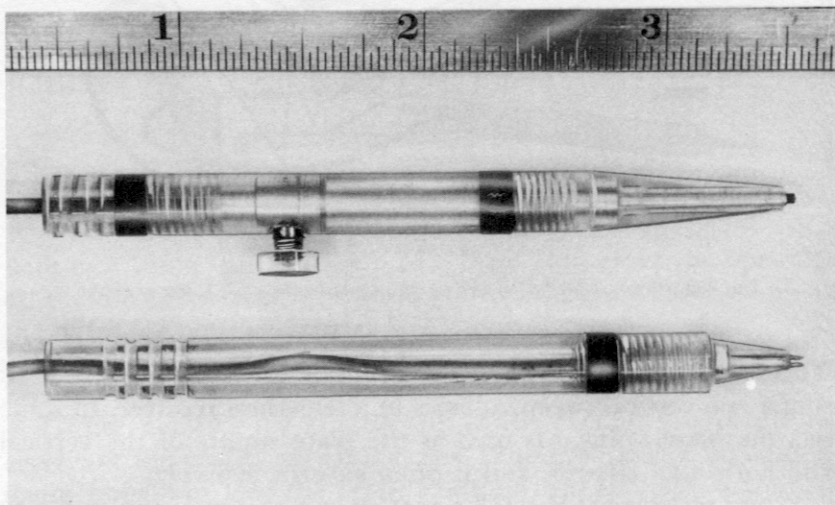

Fig. 810. *Two types of miniature test probes. The ruler shown at the top of the photograph will give you some idea of the actual size of the probes.*

tapered jaw that is simply pressed onto the wire under test. The jaw is of hardened beryllium copper, silver-plated for good electrical contact. It grips the wire with a slight spring action until sufficient pull is exerted to remove it. While service technicians often use crocodile or alligator type clips at the tip end of the probe for gripping purposes, such clips are too bulky and unwieldy for servicing in crowded spots of radio and TV sets. If you make your own probes, you will find that the use of a push-on type jaw can be very convenient. However, no matter which type of clip action you use, you will find that being able to fasten your probe into place will release your hands for work elsewhere—adjusting your test equipment or servicing.

The jaw of the probe shown in the lower part of Fig. 810 screws into an insulating handle made of lucite (plastic) or similar non-conducting material. The probe handles shown in the illustration are $\frac{1}{4}$ inch in diameter and $3\text{-}\frac{1}{2}$ inches long. Only about $\frac{1}{16}$ inch of the metal jaw protrudes from the insulating handle, so that the danger of shorting to nearby components is minimized.

The other probe, shown immediately below the ruler in Fig. 810, is a lock-on type so designed that it cannot be removed from the wire until a release button on the side of the probe is pressed. A small hook mechanism at the end of the probe remains open only while the button is pressed and tightens on the wire

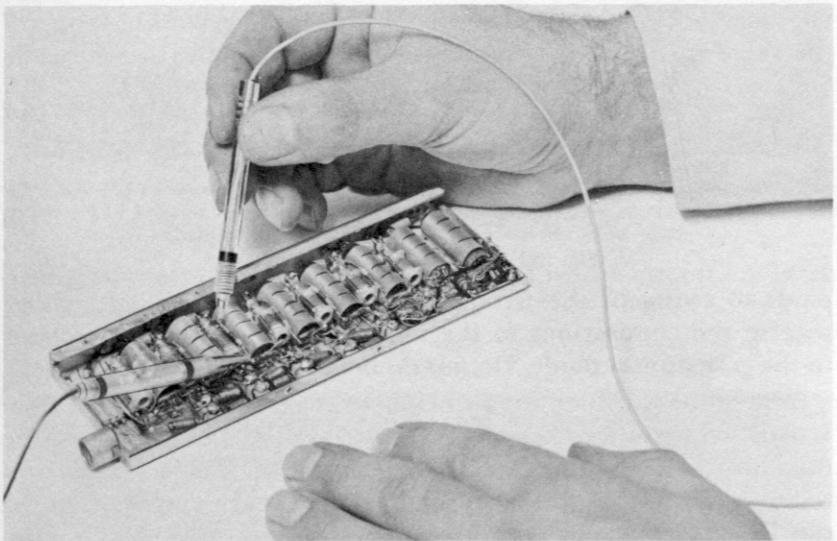

Fig. 811. This picture shows the miniature probes at work. These probes have the advantage of compactness but lack of shielding limits usefulness.

when the button is released. In other respects, including size, the lock-on probe is similar to the push-on model. Like the push-on model, the lock-on probe is designed to accommodate wires varying considerably in diameter. In Fig. 811 we see how both probes are put to work checking components in a diminutive 8-tube i.f. amplifier.

R.f. indicator probe

This probe is very useful for detecting oscillation in the r.f. stages of small transmitters, boosters for TV, etc. A simple r.f.

detector probe like that shown in Fig. 812 is helpful in detecting weak r.f. oscillations. The probe circuit is untuned so it will be easier to use, but this does reduce its sensitivity. The pickup coil of the probe may be three or four turns of self-supporting wire with an inside diameter of about 1 inch. Smaller diameter coils can be wound to meet your particular needs.

Although in the illustration we show the use of a d.c. meter having a full-scale deflection of 200 microamperes, a meter having greater sensitivity would be more desirable. The function of the capacitor across the meter is simply to bypass any r.f. and to keep such currents out of the meter. The value of capacitance is not critical. Since the voltage across the meter will be very small, you need not concern yourself with the working voltage rating of the capacitor. If, in making tests, you find that the meter needle

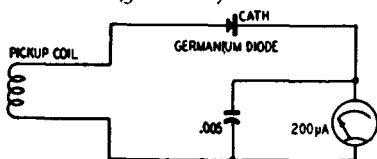

Fig. 812. R.f. detector probe circuit.

tends to swing in the wrong direction (toward the left) either reverse the connections to the meter or reverse the connections to the germanium diode. Do *not* do both.

The probe works on the principle of electromagnetic induction. It will help you locate open or shorted coils. The probe can be used only with the radio or TV set turned on. The coils that you test with this probe must be unshielded. The usefulness of the probe can be increased by having not one but a group of pickup coils, each having a different number of turns. You can wind these coils so as to slide over the end of a plastic rod. If you will mount a pair of spring clips on the plastic rod, you will be able to connect and disconnect the pickup coils quite easily.

R.f. voltmeter probe

The usual procedure for measurement of r.f. voltages is to use an r.f. probe and a v.t.v.m. However, there will be times when you will wish to test for the presence of r.f. without too much concern for the actual amount of voltage present. While you can use your v.t.v.m. and r.f. probe for this purpose, the sensitive r.f. voltmeter probe described here is extremely convenient. It is ready to operate instantly and requires no connection to the

power line. It isn't even necessary to have a ground connection as body capacitance is enough to provide a return path. But for safety's sake it is best to ground it, especially if there is high-

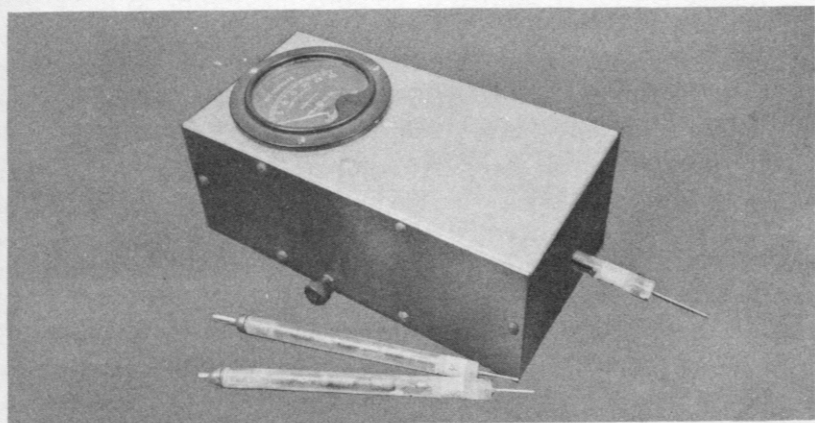

Fig. 813. Photo of the trim-looking unit and the associated plug-in multiplier probes. The positioning of the meter is not critical and may be turned to suit your convenience. An inexpensive 0-1 ma meter is used.

voltage d.c. around. Where d.c. is present in the circuit an external blocking capacitor is necessary.

Originally built for amateur use, this probe (see Fig. 813)

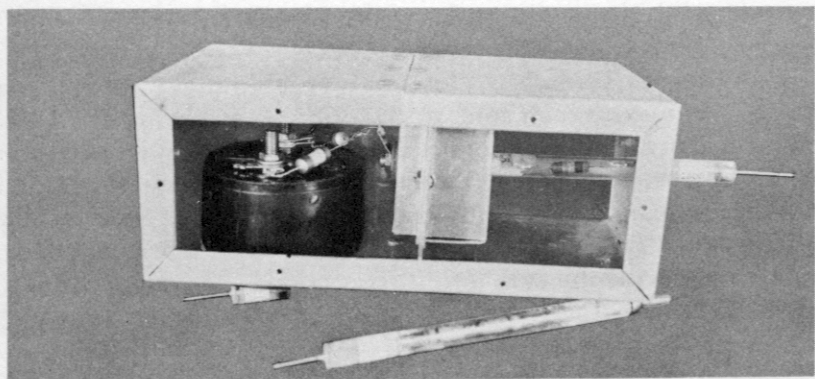

Fig. 814. View of the inner construction showing placement of the components. The metal box consists of two shielded compartments. Both sides of the metal housing are held in place by self-tapping screws. The entire probe is readily accessible for any repairs or changes you might wish to make.

can be used to measure *relative* values of the voltage (with a more sensitive meter and a higher voltage multiplier) at the plate of horizontal output tubes or high voltage rectifiers in TV sets. The

meter should present about the same load as the picture tube and the filter capacitor.

The popular germanium diode probe used for measuring r.f. voltage is usually limited to 30 volts maximum, as more than this might exceed the back voltage rating of the crystal, especially if the waveform is not a sine wave. Some crystal diode rectifiers can be used up to 150 volts, and with a capacitance type multiplier will safely read almost any voltage.

The unit described here has been used for quantitative tests on transmitters and open-wire feeder lines to antennas. The illustration, Fig. 814, shows that the case is used as a three-section shield—two sections around the probe which is also the multiplier, and one around the meter and rectifier assembly. The shield around the probe must have a low capacitance to the resistors or some of the current will pass directly to ground without registering on the meter. The multiplier must be shielded to prevent the sensitive low-voltage end of the multiplier from picking up r.f. both from the source and from the high-voltage end through distributed capacitance. The two-section box shield does this without introducing too much capacitance to ground. The capacitive effect is minimized further by using a fairly large meter current. A 0–1-ma meter is used but the over-all sensitivity is about 450 ohms per volt. This does load the circuit somewhat but for transmitting work this is not undesirable. The probe circuit is shown in Fig. 815.

The case is constructed of 52S $\frac{1}{2}$ H aluminum sheet. This alloy combines stiffness and workability. For an 8 x 4 x 3-inch case, sheeting of .025 gauge is about right. The sides, however, could be heavier since it isn't necessary to bend them. One side is riveted permanently and the other one is fastened with self-tapping screws. Two partitions reinforce the sides, shield the multiplier, and divide the case into three sections. The construction of the inner shields and banana jack support should be completed before assembling the case.

The multiplier resistance for each range may be determined by using an audio-frequency voltage and an accurate a.c. voltmeter. Start with about 450 ohms per volt. The multipliers would be accurate only for sine waves as most voltmeters read r.m.s. values. The multiplier should have at least three resistors, especially for the higher ranges. On the 1,500-volt range the resistors may dissipate a little over 3 watts so the total wattage should be adequate.

It is preferable to have the resistors in a multiplier as identical as possible in wattage and ohmage.

The probe-multipliers are made of Amphenol polystyrene tubing and rods. $\frac{1}{4}$ -inch rods just fit into $\frac{3}{8}$ -inch tubing, so these sizes are used. A $\frac{1}{2}$ -inch length of rod is drilled axially and tapped for the 6-32 thread of standard banana plugs. It is difficult to drill this straight unless the rod is placed in the drill chuck and the drill bit clamped in a vise. This rod is then cemented in the end of a piece of tubing with polystyrene cement and allowed to

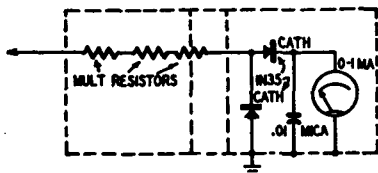

Fig. 815. Circuit diagram of the diode-type voltmeter.

harden. Then a $\frac{1}{16}$ -inch hole is drilled alongside the threads for the resistor lead. After the resistor string is made up, use a length of $\frac{1}{16}$ -inch brass welding rod at one end for the probe tip. The resistors should be so spaced that about half of the last one will be inside the inner shield when the probe is plugged in. After making a final check of the multiplier for accuracy, seal the probe end with a section of rod drilled to fit the welding rod, and cement it in place.

The meter illustrated uses four probes to give 0-3, 30, 300 and 1,500-volt ranges. The circuit was selected because it gives linear readings on all but the 3-volt scale, allowing d.c. meter scales to be used. A 1N35 dual crystal (having matched characteristics) is used in preference to the 1N34 types.

Materials for voltmeter

One 0-1-ma meter, one .01- μ f mica capacitor, one 1N35 germanium crystal, some $\frac{1}{4}$ -inch polystyrene rods, several lengths of $\frac{3}{8}$ -inch polystyrene tubing $5\frac{1}{2}$ inches long, several pieces of brass welding rod, several banana plugs, a jack with insulating washers, three matched 1-watt 5% tolerance resistors (see text), per multiplier-probe, and solder. Several .025-gauge 52S $\frac{1}{2}$ H aluminum sheets, binding posts, hardware, etc.

Probe holder

Many modern radio and TV sets are made so compactly that it is difficult to hold the probe in place by using a standard-size alligator clip fastened to the probe tip. You can overcome this difficulty by making a simple gadget which works as well.

The adapter is made from a contact out of a molded octal socket. Remove the whole contact and make a narrow slit in the eye. Now slide the contact wire over the end of your test probe. When checking circuits, signal tracing, etc., slip the eye of the contact

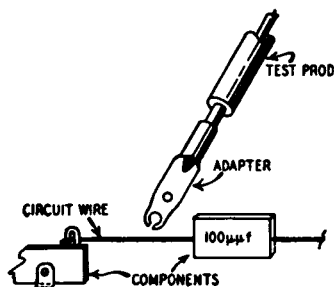

Fig. 816. Simple adapter for holding test probe in position.

adapter over the circuit wire and give the probe a slight twist to hold it in place. The illustration (Fig. 816) shows how the adapter is used.

Quadrupler probe

The probe circuit shown in Fig. 817 is unusual in that it has an a.f.—r.f. voltage-quadrupler arrangement. Voltage stepup is obtained without a transformer. The d.c. output voltage of this probe is equal to approximately 5.66 times the r.m.s. value of the

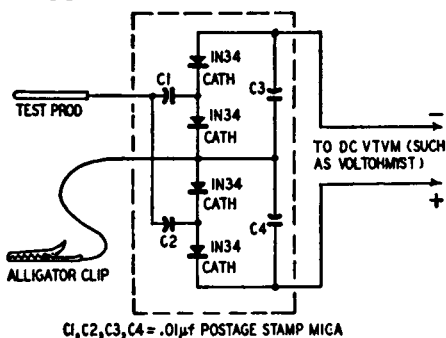

Fig. 817. Circuit diagram of the quadrupler probe. The probe is very useful for making tests in circuits having very low r.f. voltage.

input voltage. This results in much increased meter sensitivity. For example, the full-scale deflection on the 0—3-volt d.c. range of the v.t.v.m. will indicate an a.f. or r.f. input voltage of only 0.53 volt r.m.s. when this probe is used.

Although the voltage-quadrupling probe uses four 1N34 crystals and four .01- μ f postage-stamp mica capacitors, it may be built into a small-sized container. The crystal polarities indicated must be followed or the circuit will not multiply correctly.

It is advisable to make an individual voltage calibration after the probe has been completed and plugged into the d.c. vacuum-tube voltmeter, since the rectification efficiency of production-lot crystals varies and the 5.66 multiplication factor might not hold exactly for a particular quartet of crystals.

Magic-eye probe

With the a.g.c. systems included in present TV sets, the picture contrast changes very little for large changes in input signal. Therefore, it is difficult to adjust indoor antennas, outside

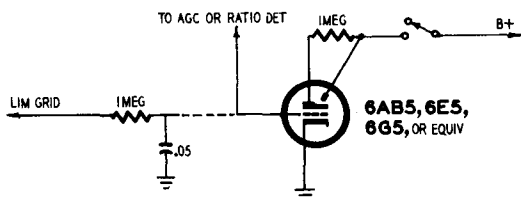

Fig. 818. Circuit diagram of magic-eye probe.

rotating beams or TV boosters, for best results. This magic-eye probe can be used when you want maximum input signal.

The probe consists of an electron-ray indicator tube. The choice of tube is not critical. You can use any of the types mentioned in the circuit diagram (Fig. 818). To build the probe, obtain a section of tubing having a length of about 4-1/2 inches and a diameter of 1-1/2 inches, approximately. The tubing can be plastic, bakelite, aluminum or any material you have on hand. The indicating face of the magic-eye tube should extend slightly from one end of the probe housing while the probe tip is mounted at the other end. You will need to bring two leads into the probe, one for B plus and the other for one leg of the filament line. These voltages can be obtained quite readily from the TV set you are working on. The two wires, filament and B plus, should terminate in shielded alligator clips which can then be attached to the desired filament and B plus voltage points in the TV set.

You can mount the magic-eye tube in a socket or solder directly to the pins of the tube. The cathode of the tube should connect to one side of the filament. From this pin run a wire

through the probe housing. This wire, about 8 inches long, will be the ground wire of the probe.

Using the magic-eye probe

If the set uses a ratio detector, touch the probe point to the negative end of the electrolytic capacitor in the ratio-detector circuit. If the set uses a limiter-discriminator circuit, the probe point should go to the grid of the first limiter through a filter network as shown in the diagram.

If there are two positions of minimum shadow close together, this means that the sound i.f. is overcoupled. Then the correct tuning position is between the two.

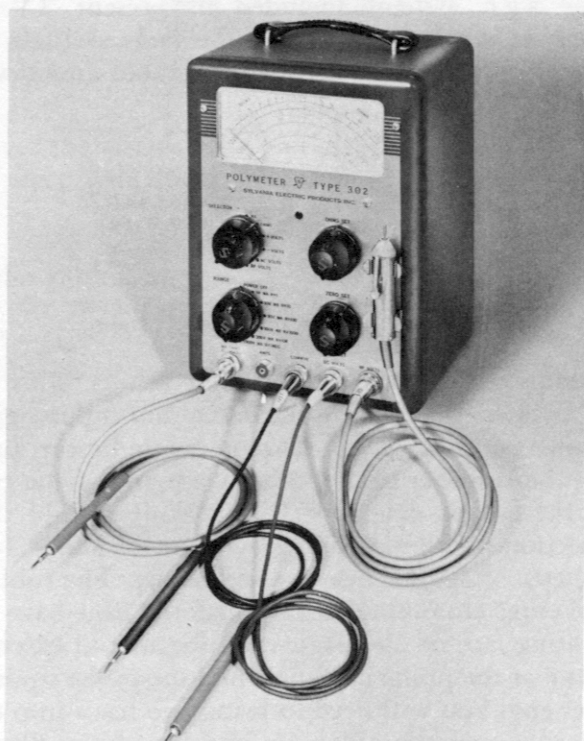

Fig. 819. *Modern test instrument showing a complete set of probes.*

Plugs and connectors

Some test instruments come supplied with a complete set of probes for just about every use. A typical example of this is shown in the photo (Fig. 819). However, it is entirely possible that your v.t.v.m. or scope did not come supplied with probes,

in which event you may wish to buy or build your own. If you decide to build a probe, you must make some arrangement for connecting the probe to your scope or v.t.v.m.

If your scope uses binding posts, the problem of connecting the probe is quite simple. Wrap a single turn of tinned wire around the exposed shield braid of the coaxial cable. Solder the

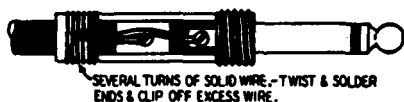

Fig. 820. Fastening a coaxial cable to a jack.

wire to the braid. The inner lead of the coaxial cable (the so-called hot lead) is usually fairly thin wire. Solder a tiny clip to this wire. Now wrap the end of the cable with Scotch tape. To make a connection to your scope, insert a 1-inch length of bare, tinned wire into the vertical binding post. When you use the probe, the clip connected to the hot lead of the coaxial cable should be fastened to this wire. The wire previously soldered to

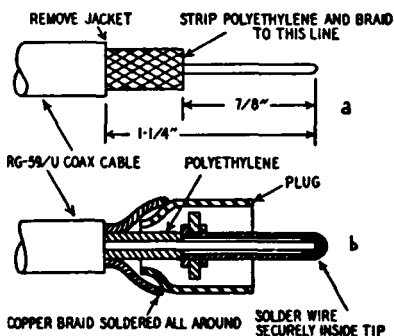

Fig. 821-a,-b. Illustration at top (a) shows preparation of coaxial cable while lower illustration (b) shows how to solder the cable to the plug.

the shield braid of the cable should be connected to the ground binding post of the scope.

If you do not observe these precautions, you will soon find that constant flexing of the center conductor of the coaxial cable will cause it to break.

A much better arrangement is to have the probe cable terminated in some kind of coaxial connector or plug. However, even with such connectors, your coaxial cable must be electrically and mechanically secure.

A coaxial cable going into a jack such as a PL-54, PL-55,

PL-68 or JK-26 should be anchored to eliminate strains on the connections. The result of the special clamping bands manufacturers use can be duplicated easily. The way in which this is done is shown in Fig. 820. After connecting the cable, wrap the clamping area with No. 20 or 22 solid wire. Then twist the two ends tightly together and apply a small spot of solder. The twisting of the ends gives a strong clamping action.

See Fig. 821 for the technique to be followed in soldering to a coaxial plug. First, remove the vinyl jacket, copper braid and polyethylene insulation as shown at *a* in the illustration. Be careful not to nick the braid or center conductor. Solder the connections as shown at *b*. Line up the cable with the body of the plug, then use a hot iron for soldering.

Tinning or soldering a wire to the shield braid of coaxial cable will cause the underlying plastic to melt and can result in a short between the center conductor and the outer braid. Prevent this by putting a piece of metal sleeving under the braid at the soldering point. Remove the sleeving after the soldered connection has been made. If you find it difficult to get the metal under the braid, push the braid back slightly and it will expand enough to allow the sleeving to be used. Work rapidly to avoid excessive heat which will damage the polyethylene insulation, thus increasing leakage. Excessive heat can also cause a short circuit between the inner conductor and the shield braid.

No matter which type of connector you use, always check it with an ohmmeter. In making this test, flex the coaxial cable with the ohmmeter leads going across the plug. The meter needle should show an open circuit condition and should not move. The cable connected to your probe should be treated carefully. Do not roll it into tight loops. If the cable should kink or knot, straighten it before using it.

Neon-bulb probe

A tiny neon bulb such as the NE-2 or NE-51 can be used as a probe. You do not have to make any connections. There are no wires going to the bulb, and the probe does not require the use of any test instruments whatsoever. There is no circuit diagram for the probe since there is no circuit. Simply mount the neon bulb at the end of a plastic tube about 12 inches in length. The inside diameter of the plastic tube should be approximately equal to the diameter of the neon bulb. If the neon bulb will not fit into the plastic tube, ream the inside of the plastic tube with the

blade of a pen knife. The NE-2 has a pair of leads coming out of the bottom of the bulb. Snip these off. The NE-51 has a bayonet type base and requires no attention on your part.

Put a small dab of Duco cement inside the plastic tube, insert the neon bulb, allow a few minutes of drying time and that's all there is to it. Your probe is ready for action.

Using the neon-bulb probe

This probe is used to test for the presence or absence of high voltage in a TV set. Bring the bulb end of the probe close to the plate cap of the horizontal output tube. If the output tube is working properly, the neon bulb will glow. No connections are

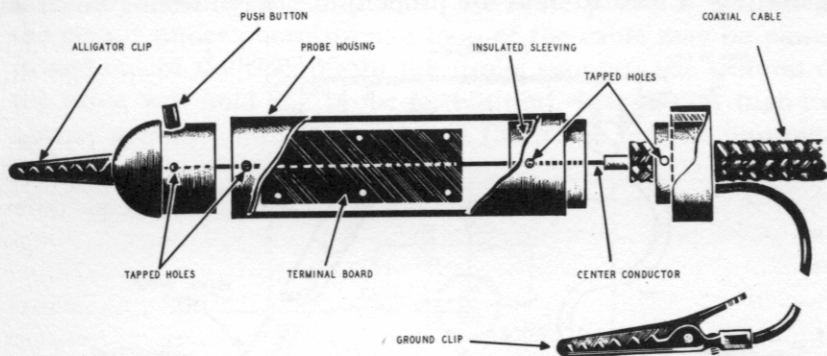

Fig. 822. Drawing of a well-constructed probe housing. Component parts can be mounted on both sides of the terminal board. Pressing down on the push-button opens the jaws of the alligator clip.

necessary. With a weak horizontal output tube, the neon bulb may glow weakly or not at all.

You can also use this probe to test horizontal output transformers. Put the probe near the plate cap of the high-voltage rectifier tube. If the horizontal-output transformer is working, the neon bulb will glow.

Probe housing

The kind of housing that you can make for your probe is limited only by your own skill, ingenuity and the kind of tools you have at your disposal. A good probe has certain desirable mechanical characteristics. It should not be so bulky that it would be too awkward to hold. The probe housing, if made of metal, should have some form of insulating material wrapped around it to prevent accidental shorting when working in close quarters

in a radio or TV set. The probe should be sturdy enough so that it will not be damaged in regular use. The cable going in to the probe must be mechanically secure. The components inside the probe—resistors, capacitors, crystals, or tubes—should be securely mounted, permitting the probe to be used in any position. The assembly of the probe should be such that you can take it apart easily in the event of damage to one or more of the electrical components or if you wish to make some changes or replacements. Choice of a probe tip depends upon the user. Some technicians prefer a needle point for the probe, others prefer a point with a clip-on action.

A typical probe housing is shown in Fig. 822. Here an alligator clip is used to hold the probe into place. Pressing down on

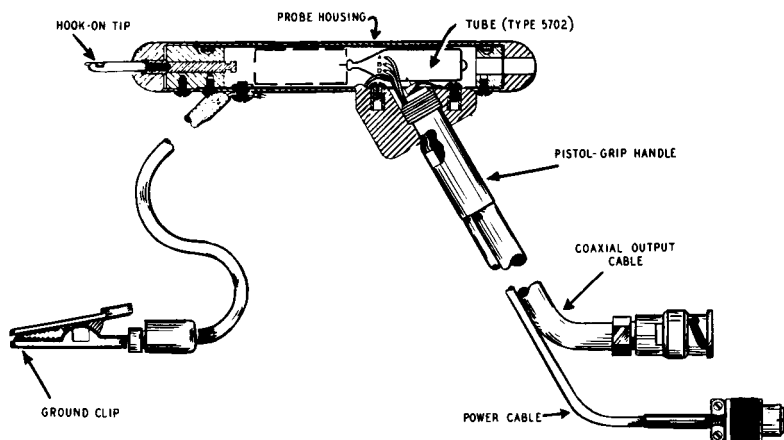

Fig. 823. Pistol-like structure of the cathode-follower gun probe. A rotating hook-on tip is a unique feature.

the push button opens the jaws of the clip, releasing the probe. The probe head is held on to the probe housing by means of a set screw rotated into a pair of tapped holes. You can substitute a needle point for the alligator clip, but for holding purposes you will still need some sort of fastening device if you want the probe to stay in place while you work.

Cathode-follower gun probe

One of the reasons for the great popularity of gun-type soldering irons, aside from their ability to heat rapidly, has been their construction in the form of a gun. Apparently, a tool with a gun handle is favored by many technicians.

This type of housing is now being used in the manufacture of probes. The probe assembly is shown in the drawing of Fig. 823. Its small fountain-pen size and pistol-grip construction make it especially convenient to handle. Connection to the scope is made through a 5-foot cable supplied with a BNC type connector and to its power supply through a 5-foot miniature power cord and locking type connector. The tip of the probe is so designed that it can be hooked onto a circuit test point and rotated a full 360° while in use, if desired. The insulated ground clip should be located as close as possible to the signal point.

A cable support is provided for use with the probe so that both hands of the user can be made free to record observations or make adjustments of equipment. After the probe is hooked to the circuit under observation, a loop of the cable may be passed in and out of the opening in the probe support; the stiffness of the cable will hold the probe in position. For certain high-frequency applications, the response of the probe may be improved

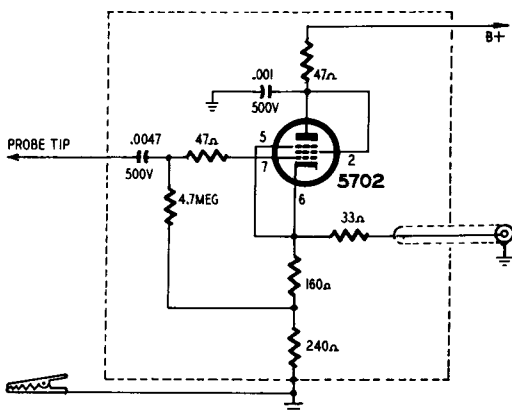

Fig. 824. Circuit diagram of the cathode-follower probe.

by either (1) shortening the length of the flexible ground lead or by replacing it with a short length of flexible braid or (2) shortening the coaxial cable.

A circuit diagram of the probe is shown in Fig. 824. The bandwidth of the probe is 5 c.p.s. to 14 mc; maximum signal input is 5 volts peak-to-peak. The approximate gain of the probe is 0.7. This is typical cathode-follower operation and means that for every 1 volt into the probe, the output is 0.7 volt. Since the probe attenuates the input signal approximately 30%, to make quantitative measurements from the plastic scale on your scope, using

the probe, special calibration must be therefore performed. To do so, connect the probe to a known peak-to-peak calibration voltage. Adjust the scope gain controls to produce the selected deflection. This can be done in the manner described on page 83 of this book.

When using the probe across a high-Q tuned circuit, a 1,200-ohm 1/2-watt composition resistor should be connected in series with the probe to prevent oscillation.

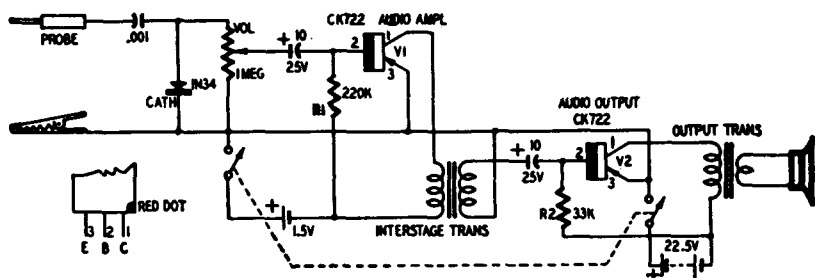

Fig. 825. Circuit diagram of the pistol-type transistor probe. The unit is completely self-contained.

Transistor probe

This little transistorized signal tracer resembles the pistol-type soldering iron used by many service technicians. It is compact and has only one outside lead—an alligator grounding clip. The pointer of the tracer is touched to the circuit being tested; the signal is rectified, amplified, then reproduced through a 2-inch speaker. The circuit diagram is shown in Fig. 825.

A .001-μf disc type capacitor couples the incoming signal to the amplifier. A 1N34 crystal rectifies any r.f. signal picked up and feeds it to a volume control. The volume control is a standard type but a midget unit could have been used. Had that been done, the d.p.s.t. switch could have been placed on the control instead of at the top of the unit.

A midget electrolytic capacitor couples the incoming signal to transistor V1. Both transistors are CK722's, mounted in hearing-aid tube sockets. Regular sockets can be used. Be careful when wiring the leads because heat from a soldering iron can easily damage transistors. A good trick is to let long-nose pliers absorb the heat. This also applies to the 1N34.

R1 is a base return and develops bias for this stage. Since transistor characteristics vary, choose R2 for the value that provides maximum volume within the applied current limits. To find the correct value, use a 500,000-ohm potentiometer in place of R1 and vary it for maximum signal. Also connect a milliammeter in series—the current should not rise higher than 5 ma. The a.f. stage is transformer-coupled to the output stage. This little unit is a Stancor UM-113: primary impedance 20,000 ohms, secondary impedance 1,000 ohms, designed primarily for transistor amplifying stages. A standard interstage transformer could be used if the signal tracer is constructed on a chassis where space is not limited. A 10- μ f electrolytic couples the signal to the base of V2. The base-return resistor R2 was measured before being placed in the circuit just as R1 was. A small output transformer feeds the amplified signal into a 2-inch speaker.

When wiring be sure the transistors are properly connected—and that neither one draws more than 5 ma. The wiring is not critical but all leads and components must be closely spaced with

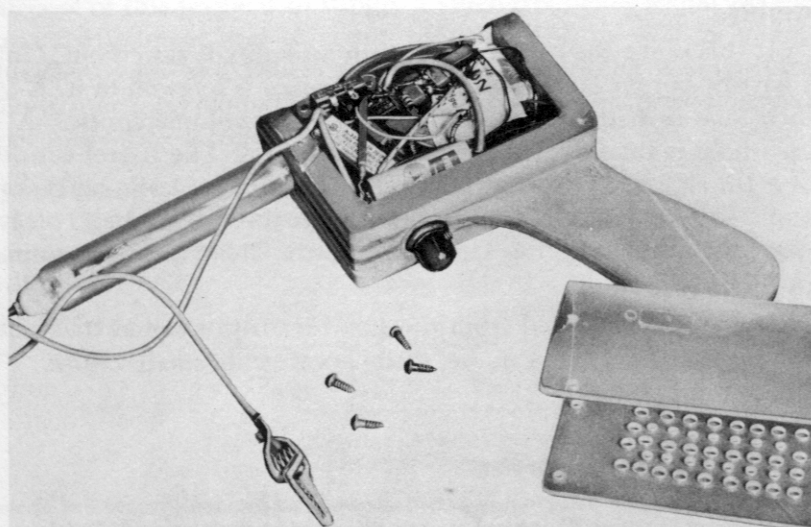

Fig. 826. Assembly of the transistor probe. The plastic cover, held on by four wood screws, has a large number of drilled holes which act as a speaker grille.

the leads as short as possible. There isn't any separate chassis, the two transistor sockets being soldered to the speaker frame. Pins

3, 4, and 5 of the hearing aid sockets are soldered together. A heavy piece of brass wire is soldered to both sockets and then anchored to the 2-inch speaker frame. The positive lug on the 22.5-volt hearing aid battery is also soldered to the 1-inch bolt fastened to the speaker frame. When plugging the transistors into their sockets, be sure both red dots or pins are plugged in properly. A d.p.s.t. push type switch is mounted on top.

Construction of the gun holder is easy. See Fig. 826. Get a few scraps of three-ply wood and draw a gun on each piece. On two of the pieces cut off the handle. Place the other piece between these and glue and nail them together. After the assembly dries, round the edges, carve and sand, giving it the appearance of a pistol. The middle section of the pistol is not sawed or cut out until the plastic is formed around it.

Lucite is used as a cover. It is fitted around the pistol assembly while heat is applied from a gas flame. Hold the plastic away from the flame. Then the plastic can be formed around the gun assembly and held there until it sets. The speaker holes can be drilled before or after the plastic is bent. All protruding corners are cut and rounded off to fit snugly around the wooden assembly.

At this point the center of the gun assembly is sawed out. Only a narrow border is left and the plastic piece is screwed to it. A $\frac{3}{8}$ -inch hole is drilled into the bottom for the volume control. A 1-inch hole is then drilled for the pistol barrel. The barrel consists of a 1-inch piece of round plastic tubing with a plastic bottle cap and 2-inch bolt fastened into the end as the test probe. To save space the small coupling capacitor and the 1N34 can be mounted in the plastic tube.

The results obtained from the small transistor signal tracer are surprising. Troubles can be easily located in small radios, TV sets and amplifiers.

Parts for transistor probe

1—33,000, 1—220,000 ohms, resistors; 1—1 megohm, potentiometer; 1—.001 μ f ceramic disc capacitor; 2—10 μ f, 25 volts, electrolytic capacitors (small as possible); 1—interstage transformer, primary impedance 20,000 ohms, secondary impedance 1,000 ohms (Stancor UM-113 or equivalent); 1—output transformer, primary impedance 2,000 ohms, secondary 3.2 ohms (Stancor A-3332 or equivalent); 2—hearing-aid or transistor sockets; 2—CK722 transistors; 1—sheet of plastic; 3—pieces of 3-ply plywood; 1—2-inch speaker; 1—d.p.s.t. switch (see text); 1—1N34; 1—alligator clip; 1—plastic tubing; 1—22.5-volt hearing-aid battery.

the chromatic probe

The Chromatic Probe* is a unit designed to convert the outputs of r.f. sweep and signal generators so as to meet the sweep requirements of video amplifiers and color TV circuits. The purpose of this probe is to supply a video-frequency signal for the proper alignment and servicing of color TV, as well as monochrome (black and white) receivers. Such a probe is important (particularly for color TV) since very few of the present signal generators have a video sweep.

Probe circuit

Fig. 901 shows the circuit arrangement. It is essentially a nonlinear mixing device using three 1N56A crystal diodes con-

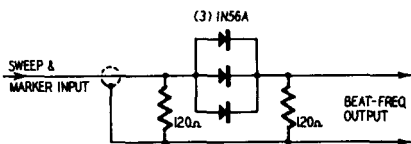

Fig. 901. *Electrical arrangement of the Chromatic Probe.*

nected in parallel. The heterodyning (mixing) action of the probe results in an upper and lower sideband when two different frequencies are applied to its input. The probe input connector is plugged into the signal terminals of an AM and an FM generator. The signals from these two different generators are then mixed in the probe network. The difference frequency between

*Simpson Electric Co.

the FM and the AM generators becomes available across the 120-ohm diode load output resistor shown in the illustration. This difference frequency can be used to test the video-frequency circuits of a TV receiver. Fig. 902 shows the internal layout of

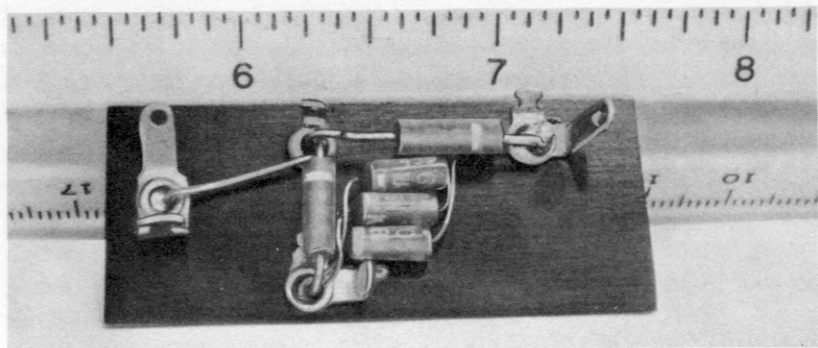

Fig. 902. Internal layout of the Chromatic Probe. The three crystals form a non-linear network. The output of the probe is the difference between the two signals that are applied to the probe input.

the probe. The small size of the probe is indicated by the ruler against which it is placed.

Development of a wide-band video sweep

In operation, the function selector of the AM generator is set to the unmodulated r.f. position. The FM generator is set for a sweep width of several or more megacycles, depending upon the bandwidth of the circuit under test. The tuning dials of both

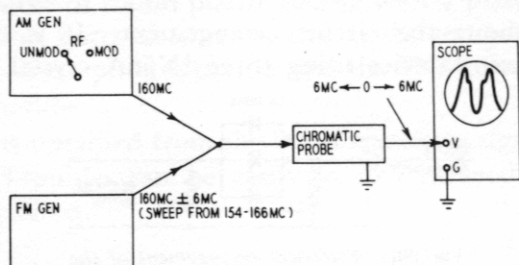

Fig. 903. Example of how a 6-mc video sweep is developed. For the settings noted, the video voltage sweeps through a 6-mc band twice in 1/120 second.

generators are set to the same frequency. If the dial of the AM generator is set to 160 mc, then the dial of the FM generator will also be set to 160 mc. The output from *both* generators is applied to the input of the probe, as shown in Fig. 903. Setting the

generators in this way will produce a twin image on the scope screen.

Single-image response

Response curves are customarily specified singly (not as twins, or mirror images) hence it is preferable to set the generator dials to obtain the sweep display only once each 1/120 second. When the dials are set to the same frequency, as shown in Fig.

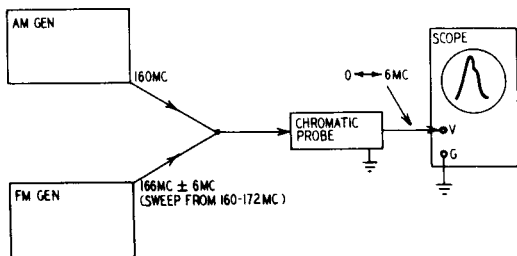

Fig. 904. To obtain a response curve in standard form it is necessary to develop one video sweep in each 1/120 second.

903, twin curves are displayed on the scope screen. When the dials are as shown in Fig. 904, a single curve appears on the scope screen in standard form. If some other sweep width such as 6 mc were to be used, then the AM generator could be set to 160 mc and the FM generator could be set to 163 mc to obtain a standard form of response curve display.

Consider a typical operating condition in which a 160-mc

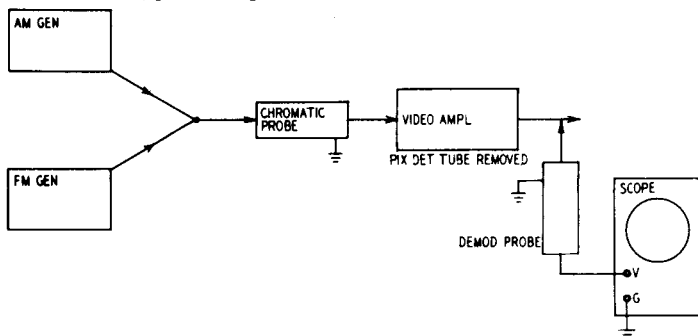

Fig. 905. Basic arrangement for sweeping a video amplifier. The output from the probe substitutes for the output from the picture detector.

center-frequency signal from a sweep generator is swept over a 5-mc band, from 157.5 to 162.5 mc, and in which a 157.5-mc signal

from a marker generator is mixed with the sweep signal. The probe modulates these signals and generates an upper and lower sideband. The lower sideband sweeps from 0 to 5 mc and is the signal that interests the color TV technician. It is the signal output used to sweep-check the Y amplifier, I, Q, chroma amplifier and chrominance circuits.

Using the Chromatic Probe

In Chapter 2 we showed how you could obtain a video-response curve through the use of two generators and a crystal

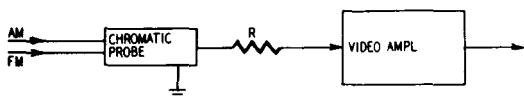

Fig. 906. Resistor *R* substitutes for the plate resistance of the picture detector.

demodulator probe. The same curves can be obtained without beating the test voltages through the picture detector when the Chromatic Probe is used. This is accomplished by using the Chromatic Probe to substitute for the action of the picture detector. The test setup is shown in Fig. 905. The output from the Chromatic Probe is applied at the input of the video amplifier. This elementary arrangement must be suitably modified to provide proper values of source impedance when various video amplifier systems are under test.

This arrangement does not provide as high a value of source impedance to the video amplifier as when the test signals are beat through the picture detector, hence the high-frequency response may appear abnormally high, unless a suitable series resistor is included in the arrangement as shown in Fig. 906. The value of the series resistor *R* should be made approximately equal to the a.c. plate resistance of the picture detector in order to obtain the same shape of response curve as when beating the test signals through the picture detector. This value may be found from tube handbooks or from crystal diode data sheets.

When making video-amplifier checks, it is desirable to keep the cable for the Chromatic Probe and the demodulator probe well separated. Otherwise you will find that sufficient coupling exists between the two cables to cause a displacement of the zero-volt reference line. Such displacement does not impair the accuracy of the curve display, but causes the zero-volt reference

line to drop below its normal level on the scope screen.

D.c. voltage at video amplifier input

A problem is sometimes presented by the presence of a d.c. voltage at the input of the video amplifier. In such cases, the probe loading resistor must not be permitted to drain off the d.c. voltage. This requires the use of a blocking capacitor as shown in Fig. 907. To choose a suitable value of blocking capacitor, remember that the reactance of the capacitor should be

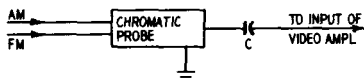

Fig. 907. A blocking capacitor, C , is used whenever a d.c. voltage is present at the video amplifier input.

less than 0.1 times the value of the input impedance of the video amplifier at the lowest frequency of test.

To make a sweep-frequency test, usually the lowest frequency of concern is 50 kc. If the 100-ohm termination of the probe is to work into a contrast control having a value of 500 ohms, for example, the reactance of the blocking capacitor should be less

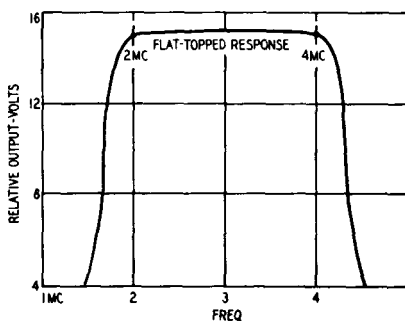

Fig. 908. Ideal response in output circuit of chrominance amplifier.

than 50 ohms at 50 kc. This means that the capacitor should have a value of at least .05 μf . To make a 60-cycle square-wave test, the value of the capacitor must be increased to present a reactance no greater than 50 ohms at 20 c.p.s. This requirement may appear to be excessive, but remember that good 60-cycle square-wave response requires relatively flat frequency response down to 20 c.p.s.

Testing color TV

There are many circuits in a color TV receiver that require video-frequency amplification, as compared with the usual single amplifier in a monochrome chassis. Fig. 908 shows the ideal response of a bandpass amplifier, as found in the output circuit

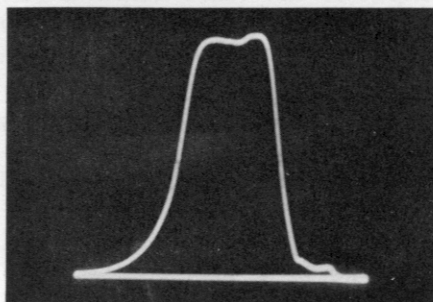

Fig. 909. Actual response curve in chrominance amplifier output circuit using Chromatic Probe.

of the chrominance amplifier. For comparison, Fig. 909 shows an actual response curve obtained with the Chromatic Probe.

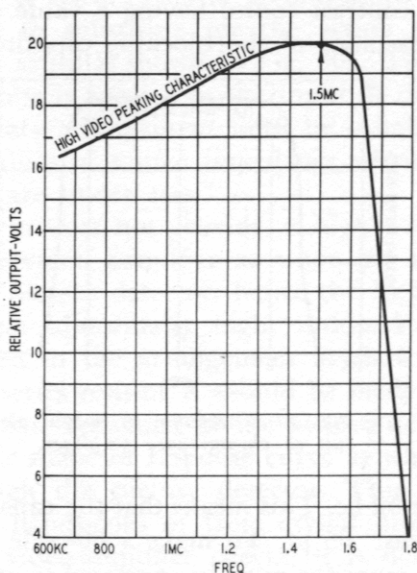

Fig. 910. The I synchronous detector curve. Note the peak at 1.5 mc.

Fig. 910 shows the ideal response for the I-channel synchronous detector. Fig. 911 shows the response obtained with the probe.

The fuzz is caused by incomplete rectification and filtering of the peak-to-peak high-frequency probe, which also attenuates the extreme low-frequency response.

The frequency response of a Q synchronous detector output circuit is shown in Fig. 912. Fig. 913 shows the response obtained with the probe. The large amount of unrectified and unfiltered fuzz is due to the use in the test of a different type of demodulator probe that uses a relatively small value of filter resistance in its

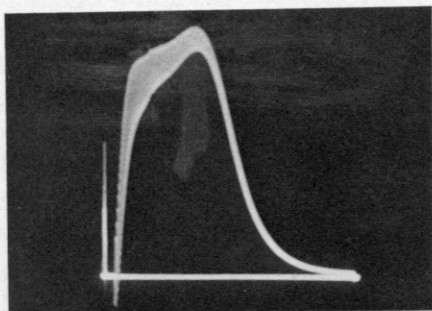

Fig. 911. The I synchronous detector curve obtained with the probe.

output circuit. It is apparent that the appearance of the video display is greatly dependent upon probe characteristics.

Certain video circuits in a color receiver are adjustable,

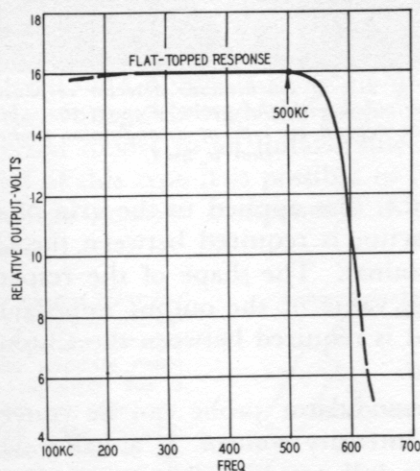

Fig. 912. Frequency response curve of the Q synchronous detector output.

while others are not. The Y channel, for example, is not adjust-

able and in the IQ system utilizes a 1- μ s delay line. It is not recommended that the technician attempt to sweep the Y channel because the delay line rings strongly and makes the test difficult to interpret. Instead, various receiver manufacturers recommend that the Y channel be checked out on the basis of d.c. measurements.

In a typical receiver, the I demodulator, the Q demodulator and the chroma amplifier contain adjustable inductors. No delay lines are included in these circuits and a ringing problem is not encountered. Fig. 914-a shows a suitable test setup for checking the chroma amplifier. This circuit includes a bandpass filter, with frequency limits from 2.1 to 4.2 mc in a typical receiver. Always consult the manufacturer's data and make the tests under the conditions specified. The example cited is only typical.

In this test setup, the output from the Chromatic probe is applied to the control grid of the chroma amplifier. This circuit

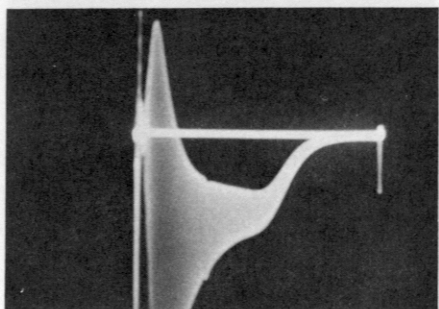

Fig. 913. Q synchronous detector response obtained with the probe. Results that you get depend on type of demodulator probe that is used.

has no external d.c. bias applied to the grid of the tube; hence no blocking capacitor is required between the Chromatic Probe and the grid terminal. The shape of the response curve being unaffected by the value of the output impedance of the sweep generator, no pad is required between the Chromatic Probe and the grid terminal.

The crystal demodulator probe can be conveniently applied across the color intensity control. If a half-wave type of probe does not provide full screen deflection on the scope, a video voltage-doubler probe of the type previously described can be used. In a test of this type give no consideration to the loading effect of the probe, since it is being applied across a low-imped-

ance point in the circuit (the color intensity control of the receiver, 500 ohms).

In the example cited, the low-frequency response of the curve drops somewhat when the output from the Chromatic Probe is applied to the *input* side of the grid capacitor, as shown in Fig. 914-b. This drop in low-frequency response is caused by the greater reactance of the 50- μf capacitor at 2.1 mc as compared with its reactance at 4.2 mc. (1,500 ohms vs. 750 ohms). This is an illustration of the necessity for consulting the test conditions specified by the receiver manufacturer before comparing curve shapes.

Since there is a d.c. voltage present on the input side of the

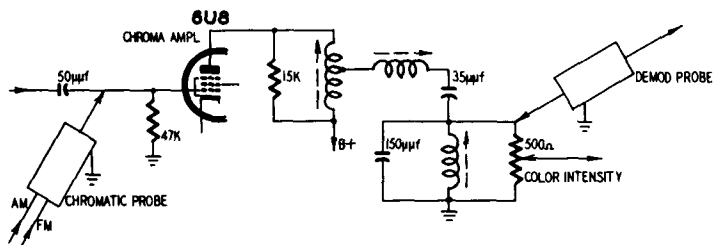
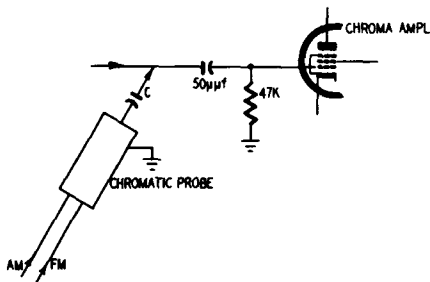

Fig. 914-a. Test setup for obtaining the response of the chroma amplifier (bandpass filter) in a typical color TV receiver. The output from the probe is applied directly to the grid of the chroma amplifier. Output from the color intensity control is demodulated through a half-wave or voltage-doubler probe, and applied to the vertical input terminals of a scope.

coupling capacitor, a blocking capacitor should be used in series with the output from the Chromatic Probe. This capacitor avoids drain off of the d.c. voltage through the probe and also prevents biasing of the crystal diodes to an unfavorable operating point. In some situations of this type it is possible to injure the crystal diodes or to damage receiver components if the blocking capacitor is not used.

Fig. 914-b. When the output from the Chromatic Probe is applied to the input side of a 50- μf capacitor the low-frequency end of the response curve is attenuated. The capacitor has a higher reactance at the low video frequencies than at high video frequencies. Blocking capacitor C may be approximately .05 μf in this type of application.



Modifications

The probe will not work unless *both* sweep and CW output

are applied. Since many generating units provide separate sweep and marker CW outputs, it is necessary to make a suitable mixing arrangement before the probe can be used. One practical solution is to remove the connector provided with the probe and substitute a Y connector to handle the output cables from the sweep and marker generators. Upon occasion, standing waves may cause trouble, but in most cases it is possible to select suitable generator frequencies to minimize the loss of flatness.

The generator frequencies should also be pure fundamentals (not harmonic or beat frequencies) or unusably low and distorted outputs will probably plague the technician. This point requires careful consideration, since the marker generator may not operate on pure fundamentals above 60 mc, delivering only harmonic output, while the sweep generator may not deliver pure fundamental output below 75 mc. In such case, suitable generating equipment must be obtained or use of the Chromatic Probe becomes impractical.

Demodulator probe limitations

In Figs. 905 and 914 we showed the use of a demodulator probe in connection with testing video and chroma amplifiers. While the Chromatic Probe provides output down to 8 kc, permitting *unusually* low-frequency tests to be made in color TV circuits, conventional demodulator probes do not respond below 50 kc. If you want to check the extreme low-frequency response of a chrominance circuit, the scope must be applied *directly* (or via a low-capacitance probe) at the signal take off point in the receiver. This procedure does not develop a conventional response curve, but a "modulated carrier wave" type of display. The envelope of this display is the frequency response of the circuit.

Chromatic Probe maintenance

With normal use you should never need to repair the probe. However, if the network should be damaged by mechanical or electrical abuse, you can replace the diodes and resistors. Use only 1N56A diodes for replacement, since a low-impedance characteristic is desirable. You can check crystal diodes for front-to-back ratio with an ohmmeter. The ratio of front to back resistance will depend on the voltage of the ohmmeter battery and on the resistance range of the ohmmeter which is used.

With a v.t.v.m. a good crystal diode will check in the vicinity of 60 ohms on the R x 1 range and well over 100,000 ohms on the R x 10,000 range.

If an ordinary crystal demodulator probe is used to provide a signal to the vertical input circuit of the scope, the response curve will "pinch off" at frequencies below 50 kc, because of

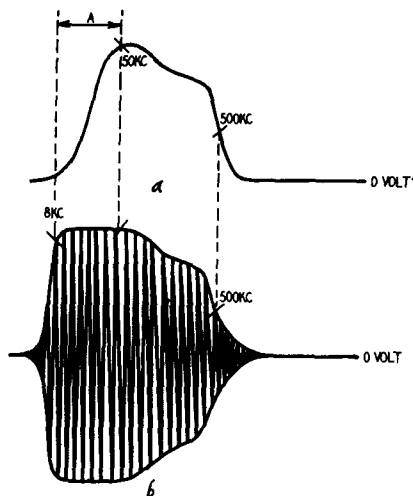

Fig. 915-a,b. Response curves: a, using demodulator probe; b, using low-capacitance probe. "A" is the area of low-frequency attenuation.

the inability of such a probe completely to rectify and filter frequencies below 50 kc.

If a low-capacitance probe is used to provide a signal to

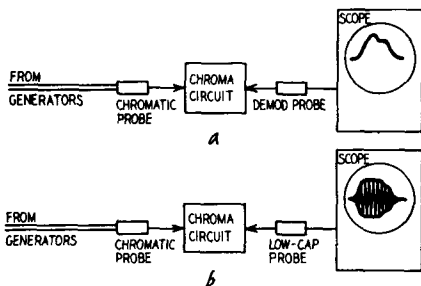

Fig. 916-a,b. Chromatic Probe test setups. The top illustration, a, shows the use of a demodulator probe, while the lower illustration, b, shows a low-capacitance probe for testing a chroma circuit.

the vertical input circuit of the scope, low-frequency attenuation

is eliminated. However, the technician usually finds the "modulated carrier wave" type of display somewhat more difficult to interpret than the conventional response curve. The difference between these two is shown in Fig. 915-a-b.

Output is not obtained from the Chromatic Probe at frequencies below 8 kc because any two generators will eventually lock when tuned near the same frequency. The point at which locking occurs depends upon the amount of coupling between them.

The two general test setups used with the probe are shown in Fig. 916. Complete low-frequency information is not obtained in *a*, because of the limitations in demodulator-probe response. Complete high-frequency information may not be obtained in *b* unless the vertical amplifier of the scope has a flat response equal at least to the bandwidth of the chroma circuit under test. Since few service scopes have a flat response out to 4.5 mc,

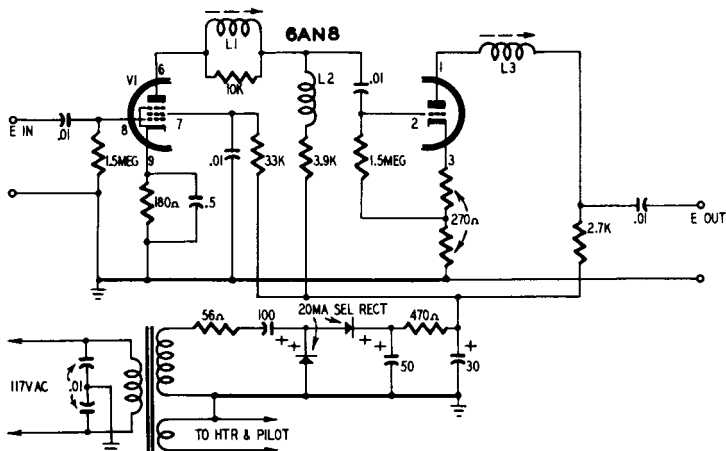

Fig. 917. Schematic diagram of the Chromatic Amplifier. All resistors are 1/2-watt. An interesting feature is the complete absence of any operating controls. The amplifier provides a gain of approximately 30 times.

the technician will usually have to make both tests to obtain complete information.

When the scope being used does not have as good a frequency response as the circuit under test, the result is distortion and attenuation of the curve at the high-frequency end. If the scope has full frequency response, either test is equally useful to determine the high-frequency response.

It may not be necessary to use a low-capacitance probe, if

the scope is applied across a low-impedance circuit point; but the probe is essential if the scope is applied across a medium- or high-impedance circuit point. Omission of the low-capacitance probe in such cases will cause substantial high-frequency attenuation.

Chromatic amplifier

Sometimes, when working in low gain circuits, you will find the deflection on the scope screen inadequate. In such cases the amplifier circuit shown in Fig. 917 can be used. The amplifier is very simple, with no adjustable controls. It is operated by plugging the amplifier unit into the power line and turning the panel switch to the on position. Instead of applying the demodulator probe directly to the receiver circuits, the amplifier is interposed, as shown in Fig. 918. A gain of 30 is developed

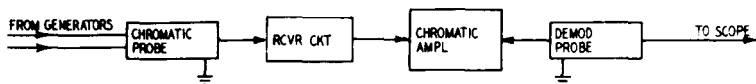

Fig. 918. It is sometimes desirable to boost the signal level to the scope when testing in very low-gain circuits. Use the amplifier between the receiver and the demodulator probe as shown.

by the amplifier over a band of 4 mc. The output is flat within ± 0.5 db from 8 kc to 4 mc. The input impedance is high and the output impedance is approximately 2,200 ohms.

All resistors in the amplifier are $\frac{1}{2}$ watt, 10%. L1, L2 and L3 are peaking coils. Their function here is similar to that of similar peaking coils in the video amplifier of a TV receiver—namely, to insure wide-band response. L1 and L3 have a range of 102 to 212 μ h while L2 is fixed at 93 μ h. The power supply uses a voltage-doubler circuit, developing a plate-supply voltage

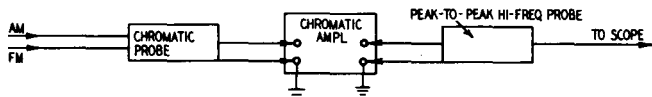

Fig. 919. Test setup for checking flatness of video sweep output from the Chromatic Probe. In this application the amplifier operates also as a filter.

of about 250. Low plate-supply voltage can result from aging of the electrolytic capacitors or the selenium rectifiers.

The amplifier pentode is series-shunt-peaked, and the triode is series-peaked, with negative feedback in the cathode circuit. The triode grid leak is connected to the midpoint of the feedback resistor to obtain the proper operating point. The series peaking

coil of the pentode is damped to flatten the frequency response and avoid excessive high-frequency peaking. However, the series peaking coil of the triode section is undamped because of the lower plate resistance of the triode.

The series peaking coils have adjustable cores to permit equalizing of the frequency response in case the 6AN8 is replaced. They also compensate for slight tolerances in the factory wiring. By slight stagger-peaking for a 4-mc rise, the over-all frequency response is flat within $\pm 1/2$ db to 4.5 mc.

The frequency characteristic of the pentode section depends substantially upon the value of the plate-load resistor (nominally 3,900 ohms). If the high-frequency response becomes abnormally high or low, the value of this resistor should be checked.

The test setup shown in Fig. 919 is very useful for checking the flatness of the video sweep from the Chromatic Probe. If the sweep is flat, the sweep trace appears as shown in Fig. 920. If the sweep trace is not flat within $\pm 5\%$, there is some fault in the equipment arrangement which should be corrected before proceeding with service tests.

Fig. 921 shows a similar test setup which is used to check the flatness of the sweep output from the Chromatic Probe when loaded by the input circuit of the receiver under test. There should be no variation from flatness in the sweep trace when this test is made. If there is excessive capacitance across the input circuit of the receiver under test, high frequencies will be attenuated. Normally, this will not happen.

After you have determined that the sweep input voltage to the receiver is flat, connect the amplifier as shown in Fig. 922 to

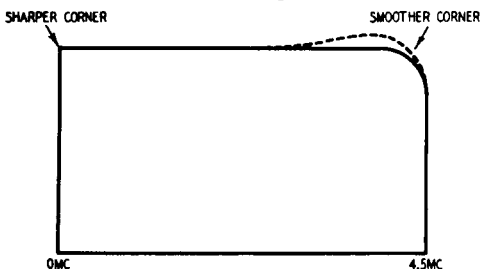

Fig. 920. Appearance of sweep trace when output from Chromatic Probe is flat. There may be a slight high-frequency rise, as indicated by the dashed line. This does not exceed $1/2$ db.

observe the response of a video-frequency circuit in the receiver under test.

A shielded cable can be used with the amplifier for making connections to all low-impedance points in a color TV chassis. A shielded cable has a value of shunt capacitance sufficient to affect the high-frequency response of high-impedance circuits.

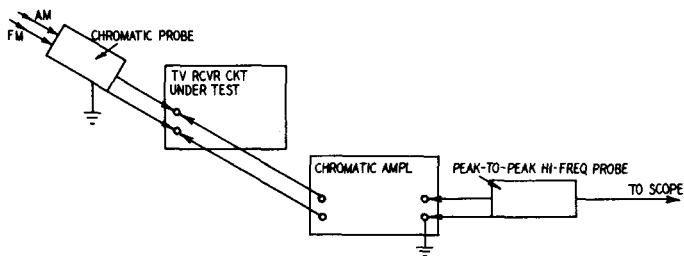

Fig. 921. Use of the amplifier to test the flatness of the sweep output from the Chromatic Probe when loaded by the input circuit of the receiver under test.

Most sweep tests in color TV receivers are made with the signal take-off point chosen at a low-impedance point, such as at the cathode of a phase-splitter tube.

However, you may encounter situations in which the signal take-off point is in a relatively high-impedance circuit, such as 5,000, 10,000 or more ohms. In such cases it is impractical to use a shielded input cable to the Chromatic Amplifier. Instead, use a pair of open test leads to minimize the shunt capacitance. Open test leads are avoided when possible because there is greater tendency for such leads to pick up stray voltages, such as horizontal and vertical sweep pulses.

Whenever interference from sweep circuits is excessive, you can avoid the difficulty by removing the sweep output tubes. In case the power supply voltage rises excessively upon removal of the tubes, you can put a dummy resistor load across the output of the power supply.

In many tests, the use of the amplifier is not necessary, but you will need it in the testing of some low-gain circuits in color TV. Typical low-gain circuits are the chroma amplifier and the I demodulator circuits. The Y amplifier is also a low-gain amplifier

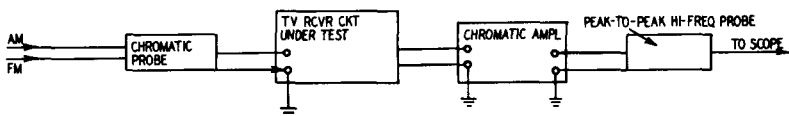

Fig. 922. Typical arrangement of Chromatic Probe, Chromatic Amplifier, and peak-to-peak high-frequency probe in testing a low-gain color-TV video frequency circuit.

but is infrequently checked by sweep methods because of the strong ringing of the delay line.

When a very low-resistance load is shunted across the Chromatic Probe, it may sometimes be observed that the high-frequency response tends to rise somewhat when checking the flatness of the sweep input voltage. In such case, the high-frequency response can be flattened by inserting a small series resistance of 100 ohms or more between the output of the Chromatic Probe and the input of the receiver under test. In rare instances, the nature of the load on the Chromatic Probe will be such that the low-frequency response will tend to rise; in such case, a series capacitor of suitable value will serve to flatten the low-frequency response.

Color circuit checks

The Chromatic Amplifier does not have to be used in all color receiver circuit checks. When the circuit under test provides some gain, rather than loss, the amplifier becomes superfluous; for example, tests of the red, blue and green video amplifiers do not require signal boost. However, tests of the Y channel or the matrix elements require amplification to obtain full-screen deflection (unless a very substantial input signal or a very high-gain scope is used).

Using the amplifier

Fig. 923 shows the three possible arrangements for an amplifier when used to boost the signal into or out of a circuit under test or out of a probe to obtain full-screen deflection on a low-gain scope or for testing a very low-gain circuit. Fig. 923-a is satisfactory from the standpoint of operating stability, but is more costly because the amplifier must work into a different circuit impedance for each test. Circuit impedances may vary from that of a 500-ohm contrast control to the grid circuit of the chroma amplifier. The shunt capacitance values in such circuits vary considerably. Hence, if this method is used, a second tube is required in the amplifier so that a very low output impedance (such as 75 ohms) can be obtained. However, the use of an extra tube should be avoided if another method will prove more practical.

The second arrangement (Fig. 923-b) offers a very attractive feature in that the amplifier may now work into a constant load impedance; the input impedance of the probe. If the specified probe is used with the amplifier, a pentode-triode will develop the de-

sired gain with response flat within $\pm 1/2$ db over the range of 8 kc to 4.5 mc in all tests.

Bounce

Placing the amplifier between probe and scope might make it possible to use a relatively narrow-band amplifier, requiring one less section in the tube envelope. This arrangement (Fig. 923-c),

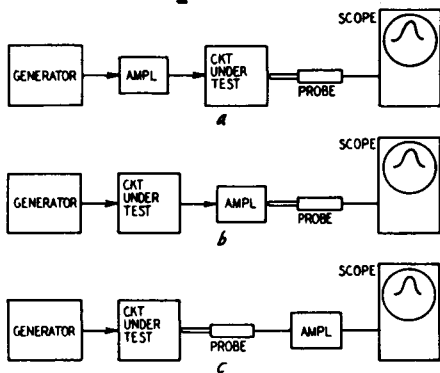

Fig. 923-a,b,c. In the drawings above we have three possible arrangements of the Chromatic Amplifier.

however, is not practical for service work. Although the amplifier need not have a frequency response above 50 kc for the intended purpose, the low-frequency response of the amplifier must be extended to 20 cycles because a demodulated signal is now being amplified. With a low-frequency response of this type, "bounce" becomes a severe problem since any small variation of line voltage, such as is caused by snapping a light switch on or off, causes the pattern to bounce off-screen. The difficulty can be avoided by operating the receiver under test from an automatic line-voltage regulating transformer. Service shops do not commonly have this type of transformer available for bench work, so the arrangement shown in Fig. 923-b represents the most economical method for the service bench.

The amplifier does not respond to changes in source impedance, thus the input voltage from the circuit under test may be obtained from a low-impedance source such as the cathode of a phase-splitter tube or from a high-impedance one such as the grid of a picture tube, without disturbing the amplifier response. However, the input capacitance of the amplifier is important to the circuit under test since unsuitable test leads may shunt so much capaci-

tance across a high-impedance TV circuit that its operation is disturbed and a distorted response curve obtained.

Effect of shielded cable

A shielded input cable has much more capacitance than does a pair of open test leads, but it is effective in minimizing the possibility of stray field pickup such as flyback pulses. Whenever a shielded cable is to be used in a high-impedance circuit, the possibility of circuit loading must be kept in mind. It is better to "kill" the horizontal sweep section of the receiver and use a pair of open test leads rather than take the chance of disturbing the normal operation of a high-impedance circuit with a shielded cable. Fortunately the majority of signal takeoff points in a color TV chassis can be obtained at low-impedance circuit points.

Bandwidth of scope

The present trend is toward the use of wide-band scopes that provide full gain at the color subcarrier frequency, and of course the gain of such scopes is relatively low. When such a scope is used for alignment work, the Chromatic Amplifier will be required for a greater number of tests. Some wideband scopes, however, provide a dual band arrangement, so that the input circuit can be converted by switching for high-gain narrow-band response. In such case, alignment checks can be made in the high-gain position of the switch, and the Chromatic Amplifier will be called upon less often to boost the test signal.

vacuum-tube probes

The advantages and disadvantages of vacuum-tube versus crystal probes were discussed in an earlier chapter. Although in recent years crystal probes have achieved considerable acceptance for servicing work, vacuum-tube probes are still widely used.

The length of time it takes for electrons to travel from the cathode of a tube to the plate is known as *transit time*. Transit time becomes important when you start working in circuits operating at frequencies of approximately 50 mc or higher. The relationship of such high frequencies to transit time can cause a phase shift between plate current and grid voltage and can result in a change in the input conductance of a tube. There are other modifications that will take place in the characteristics of the probe tube, to such an extent that the voltage output of the probe will not be a true measure of the signal being tested.

For these reasons, transit time imposes a limitation on the high-frequency range of vacuum-tube probes. The practical, upper-frequency test limit can be extended by using miniature diodes designed for work at very high frequencies.

Contact potential

It is quite possible for a very small current to flow from the cathode of a vacuum-tube diode to the plate, even though the plate is not connected to any source of B plus voltage. If this current is as small as 0.1 ma, it will produce a potential of 1 volt when flowing through a 10,000-ohm resistor. The effect of this current

is to make the plate of the diode negative (by 1 volt in this instance) with respect to the cathode. This means that if the diode is used as a probe, the incoming signal must have a peak value of more than 1 volt before it can make the plate of the diode positive with respect to the cathode. This reduces the sensitivity of the diode, since there are times when you will wish to measure potentials smaller than 1 volt.

In Fig. 1001 a resistor is shown connected between the plate and cathode of a diode. The flow of current due to contact potential is in such a direction (as shown by the arrow) that the top end

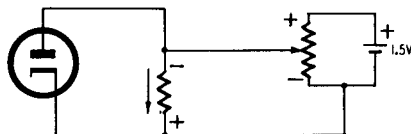

Fig. 1001. Basic circuit for overcoming the effect of contact potential.

of the resistor is negative. Since this resistor is in parallel with the diode, the voltage and the polarity between plate and cathode of the tube are the same as that across the resistor.

To overcome the effect of contact potential, an opposition or bucking voltage is applied to the diode. In Fig. 1001 we have a 1.5-volt cell shunted by a potentiometer. Note that the polarity of the voltage across the potentiometer is in opposition to that developed by the load resistor across the diode. With the proper setting of the potentiometer the contact voltage developed by the diode is neutralized, the diode then becoming responsive to small signal inputs. The bucking voltage can be taken from a voltage-divider tap in the v.t.v.m. Some probes use a duo-diode, one-half of which is used to rectify the signal being tested, the other half of the tube supplying the bucking voltage.

High-frequency probe

You can use a high-impedance, vacuum-tube type rectifier probe for measuring high-frequency voltages. The tube in the probe housing rectifies the high-frequency a.c. voltage under test to a proportionate d.c. value and feeds this voltage to a v.t.v.m.

The circuit of a typical high-frequency probe (often called an r.f. probe) is shown in Fig. 1002. The probe is a peak indicating type. Its d.c. output has value approximately equal to the positive peak voltage of the a.c. applied to the tip of the probe. Basically, this relationship between the a.c. input and the d.c. output of the

probe is true only when the rectified probe output feeds into an infinitely high d.c. load resistance.

The input of a vacuum tube (control grid-cathode circuit) is a suitable load. Since the input resistance of a v.t.v.m. is less than infinite, the rectified output of the probe is never quite truly equal to the full peak a.c. input to the tip of the probe. However, the difference is small enough to permit calibration on the basis of true positive peak voltage.

As shown in the circuit diagram (Fig. 1002) the probe uses a 9002, diode-connected. Another tube type that is used is the 1247. A certain amount of contact potential will be noted, particularly if your v.t.v.m. is set to read between 1 and 3 volts d.c.,

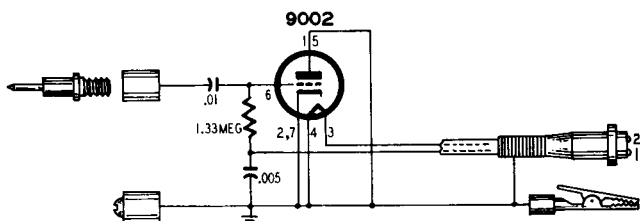

Fig. 1002. *Peak-indicating high-frequency probe (r.f. probe).
The tube is connected as a diode.*

full scale. If contact potential produces a deflection on your v.t. v.m., simply rotate the zero-adjust control until the meter needle is back to zero. Contact potential decreases in nuisance value when you measure voltages of 10 or more. For such checks, contact potential will barely disturb the original zero setting of your v.t.v.m.

The relationship between the true peak voltage at a test point and the meter reading on the d.c. scale of the v.t.v.m. is shown in Fig. 1003. This graph also indicates that the useful working range of the probe is between 0.2 volt and 200 volts peak, approximately. These are low- and high-frequency a.c. voltage values commonly encountered in the servicing of radio and TV sets.

Voltage measurements in high-frequency, high-impedance circuits usually cannot be made with a low-impedance a.c. measuring instrument such as a multimeter having a sensitivity of 1,000 ohms per volt. Such tests must be made with a suitable high-impedance test instrument. The probe that is used should be specifically designed to yield the greatest over-all accuracy in the high-

frequency a.c. spectrum. Measurements at low frequencies, however, can be satisfactorily done with the usual multitester.

The d.c. output of the probe whose circuit appears in Fig. 1002 is negative with respect to ground. If you have a center-reading v.t.v.m., this means that the meter needle will swing left. Some v.t.v.m.'s have a plus-minus control whose setting permits the needle to move in a forward direction, regardless of the polarity of the d.c. input voltage.

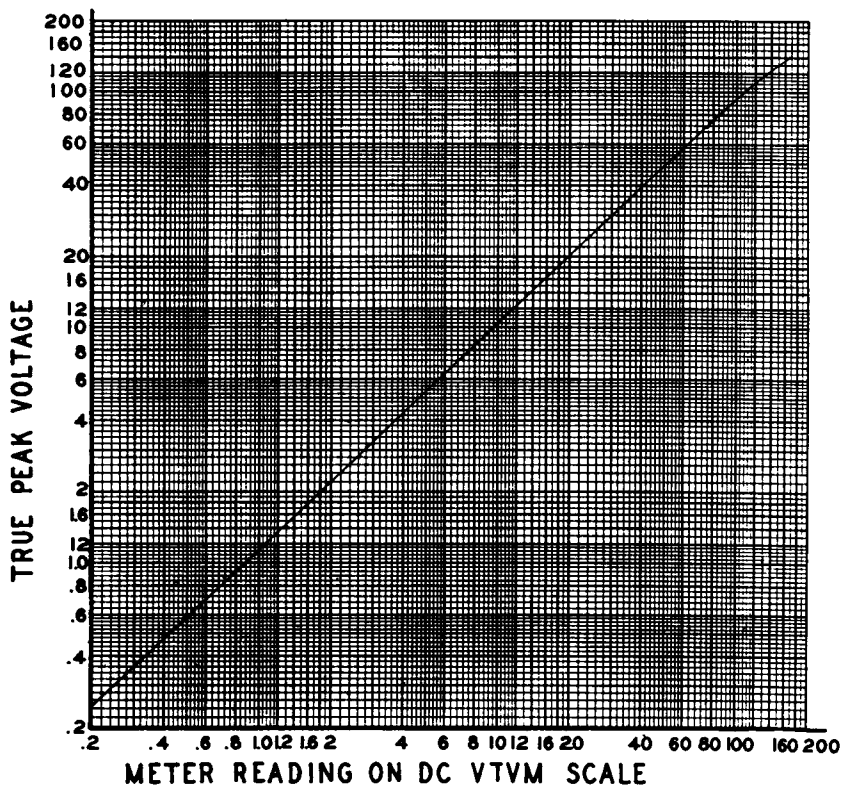

Fig. 1003. Graph shows relationship between peak voltage at test point and meter reading on your v.t.v.m.

Ground leads

Although we have mentioned the importance of short ground leads in various places throughout this book, it is once again forcibly emphasized in the construction of this probe. If you will examine the photo (Fig. 1004), you will see that there are *two* ground connections on the probe. One of these is a ground stud mounted directly on the probe head. In addition, a flexible lead

terminates in an alligator clip which extends from the rear cap of the probe. This flexible lead should be used only when measuring relatively low-frequency voltages. All high-frequency measurements should be made using as short a lead as possible connected to the ground stud on the head of the probe. The use of this stud provides a much shorter ground connection, minimizing both the ground return loop and the degree of input capacitance which will be shunted across the circuit to be measured when the probe is applied.

The capacitance of such probes, even though kept to a very low value, can still be sufficiently great to detune resonant circuits

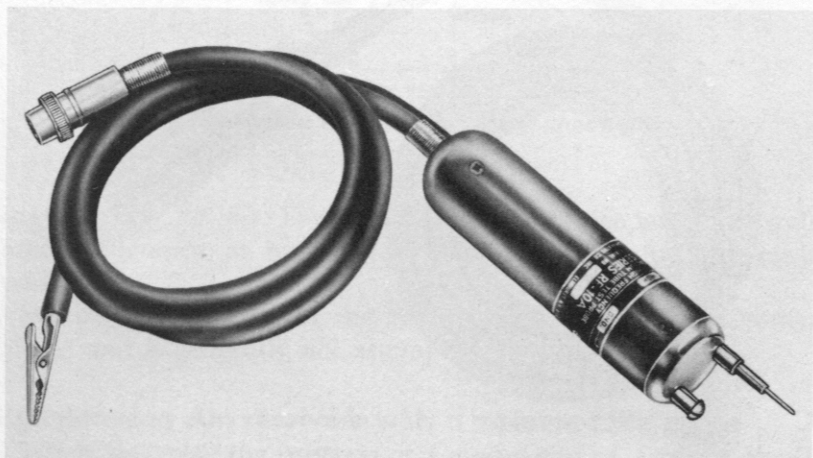

Fig. 1004. Probe comes equipped with two grounding points. The stud on the probe head should always be used when making tests in high-frequency circuits.

using a low C to L ratio. Whenever you make measurements in resonant circuits, return the circuit to resonance with the probe point making contact before you take a final reading on the meter. If you do this the additional shunt capacitance introduced by the probe will be satisfactorily minimized. After the probe has been removed and your checks are completed, the circuit tuning slug or trimmer capacitor can be returned to its original position.

Another commercial type of high-frequency or r.f. probe is shown in Fig. 1005. This probe uses a 1247 subminiature tube type. The special design of the tube makes possible a compact probe that provides a flat frequency response to 300 mc and which is usable to 500 mc. The probe has an input rating of 300 volts and a high input impedance of 2.3 megohms with only 3- μ f input capacitance.

This probe comes equipped with an alligator type ground clip which is welded directly to the metal housing of the probe. A short extension lead with an attached alligator clip can be screwed on to the front end of the probe for use in applications at lower frequencies. The probe circuit diagram is illustrated in Fig. 1006.

When a d.c. voltage in excess of 350 exists in a circuit being measured for r.f., use an external blocking capacitor of appropriate capacitance and voltage rating between the probe tip and the voltage to be measured. For low frequencies a value of .01 μf

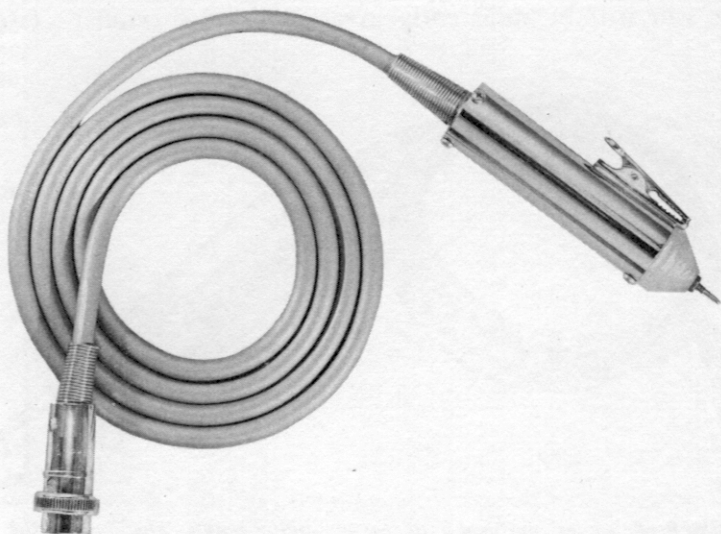

Fig. 1005. This r.f. probe uses a subminiature tube. The clip, fastened to the head of the probe, permits simultaneous grounding and clip-on action.

is generally satisfactory. For higher frequencies, a small value of capacitance is suitable. The capacitor must have a d.c. working voltage rating at least equal to (and preferably much higher than) the d.c. voltage present at the point being tested.

Servicing TV with the r.f. probe

An r.f. probe can be used to measure the strength of the local oscillator voltage in TV sets. Usually this voltage has a frequency equal to the sum of the signal frequency plus the intermediate frequency. On channel 13, for example, this would be about 250 mc. This means that your probe must be accurate to 250 mc, preferably to 300 mc.

To test the oscillator, touch the tip of the probe to the plate of the oscillator tube or the anode grid of the oscillator section. The ground point of the probe must be as close to the plate pin of the tube (or other test point) as you can get it. The lower the input capacitance of the probe you use, the less detuning effect you will notice.

Sometimes in servicing front ends it is rather difficult to get the probe tip to reach the test point. Some service technicians wrap a small piece of wire around the probe tip to extend its

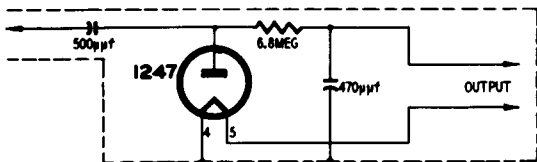

Fig. 1006. Circuit diagram of the probe illustrated in Fig. 1005.

length. *Never do this.* Even a small piece of wire will have sufficient inductance at high frequencies to give you misleading results.

Making adjustments in the front end of a TV set is rather critical and is generally not attempted.

Signal-tracing AM receivers with a vacuum-tube probe

When you trace the progress of a modulated r.f. signal through the r.f. and i.f. circuits of an AM receiver (up to the detector stage), you are actually doing nothing more or less than estimating the gain of each stage. To test an AM set go through these steps:

1. Connect an AM generator across the antenna terminals of the receiver. Put your r.f. probe across the antenna terminals and adjust the signal generator for an output of about 0.1 volt.
2. Set the receiver at the same frequency as the signal generator. Short the receiver a.v.c.
3. Set your v.t.v.m. on a low-voltage scale.
4. Now measure the r.f. voltage at the grid of the r.f. tube. Similarly, measure the voltage at the plate of the same tube. The ratio of these two voltages gives you the gain of the r.f. stage. The higher the frequency you want to measure, the shorter must be the connection between the probe and the circuit under test. Direct ground and short leads are the rule when you

use an r.f. probe. The best ground at high frequencies is to have the metal shell of the probe contact the chassis.

5. Turn the signal generator output down to zero. Test the oscillator voltage at the oscillator grid and plate.
6. Now increase the signal-generator attenuator control to its original setting. Measure the signal-generator output voltage once again and also the voltage at the plate of the converter tube. The ratio of these two voltages is the conversion gain of the converter tube.
7. Measure the voltage at the plate of the first i.f. tube. The ratio of this voltage to that on the plate of the converter tube is the gain of the first i.f. stage.
8. Making a measurement at the input to a tube (usually the control grid) and also at the plate of that tube and comparing the results, gives the gain of the stage. In this way, you can proceed right up to the input of the detector tube.
9. Since you disabled the a.v.c. you may have to reduce the signal generator output as you get toward the detector tube. Without a.v.c. it is possible for the second i.f. stage (or possibly the last i.f. stage) to become overloaded. After making all your tests, be sure to remove the a.v.c. shorting lead.

For signal tracing with a crystal-demodulator probe see page 27.

Signal-tracing FM receivers

You can use the same testing procedure on an FM set that you follow on an AM receiver. Although FM i.f. stages operate at a much higher frequency than AM i.f. stages, you will find that the r.f. probe will cause much less detuning. This is due to the broad-band characteristics of FM i.f. stages.

Older types of FM sets using discriminator detectors have one or two limiter stages. Some sets with ratio detectors also have a limiter stage. You will find that the gain of a limiter stage will remain fairly constant, even if you increase the input signal. Actually, this is a good test of the effectiveness of limiting action, since it is the job of a limiter to supply a constant output voltage. The input to a limiter varies between 2 and 6 volts r.f. A limiter requires a minimum input voltage for limiting action to be effective. If the input voltage drops below about 2 volts r.f., you will find that the output will no longer remain constant.

Peak-to-peak probe

The peak-to-peak probe whose circuit is shown in Fig. 1007 is

very much like its crystal-diode equivalent described in Chapter 3. Circuitwise the two probes are the same. The only differences are in the use of a duo-diode 6AL5 in place of a pair of crystals and different values for the components.

The flow of current in the probe is quite easy to understand. Assume that you wish to measure an a.c. voltage of some kind. This could be either a sine wave or some pulse waveform. At any moment such a wave would be either positive or negative. For the instant, assume the wave to be positive. This puts a plus voltage on two elements of the diode. The plate of the first diode (pin 2) and the cathode of the second diode (pin 1) are now positive. This means that the first half of the diode will conduct. Current will flow from the cathode (pin 5) to the plate (pin 2). This current will then flow through the 4.7-megohm load resistor R1 and then back to its starting point, cathode pin 5.

Because of this current flow, a voltage will appear across R1. Note that this current, moving in only one direction, is d.c. C1

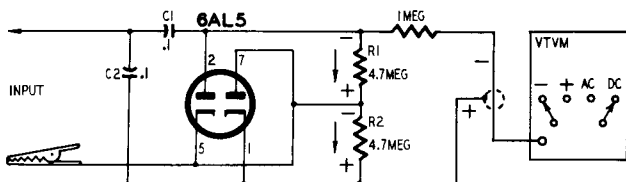

Fig. 1007. Peak-to-peak probe uses 6AL5 duo-diode. The arrows show direction of current flow through the diode-load resistors.

serves to block the passage of this current back to the signal source. During the positive half of the input wave, current does not flow through the second half of the diode, since the cathode of that part of the tube has been made positive with respect to its plate.

Assume now that the input waveform becomes negative. The plate of the first diode assumes this polarity and that half of the tube is cut off. The cathode of the second diode (pin 1) also becomes negative. This has an effect equivalent to making the plate (pin 7) positive. Current will now flow from the cathode (pin 1) to the plate (pin 7). This current will then move through R2 in the direction indicated by the arrow. A voltage will appear across R2.

Observe the polarity of the voltage drops across R1 and R2. These voltages, produced by the positive *and* negative portions of the signal being tested, are additive since they are in series aiding. If you will trace the circuit carefully, you will see that C1

and C2 are connected across diode load resistors R1 and R2. The effect is just as though we had a single capacitor shunted across the load resistors. C1 and C2 will be charged by the voltages of R1 and R2.

The voltage across R1 does not appear at the same time as the voltage across R2. The voltage across R1 becomes zero *before* the voltage across R2 is developed. Similarly, the voltage across R2 becomes zero before current flows once again through R1. However, this off-again on-again effect is overcome by placing a capacitor in parallel with the resistors. The capacitors (C1 and C2) become charged and maintain the charge through many cycles of the input wave. A measuring instrument, such as a v.t.v.m., placed across R1 and R2 will measure the sum of the two voltages. Large values of resistance and capacitance are deliberately chosen for R1, R2, C1 and C2 so that the output will closely approximate the peak-to-peak input. In some probes of this type, still larger values of resistance and capacitance are used.

If you will examine Fig. 1007 you will readily see that the center connection of the two diode load resistors R1 and R2 is directly wired to the alligator clip. This clip is usually connected to the chassis of the receiver. The bottom connection of R2 is wired to the shield braid of the probe cable; this in turn becomes part of the v.t.v.m. ground circuit. This means that you should not connect the chassis of the v.t.v.m. to the chassis of the set being repaired. If you do so, R2 will be shorted. While no damage will result, you will very definitely get an incorrect reading on the meter. If you do your service work on a metal-top bench, then slip a piece of plastic, heavy cardboard, or similar insulating material under the v.t.v.m.

Cathode-follower probe

Inverse feedback (negative or out-of-phase feedback) is often included in audio amplifiers to improve the frequency response. The same idea can be used in a probe (see Fig.1008) where the prime requirement is transference of the signal (without distortion) from the set being tested to the scope.

The cathode-follower circuit lends itself very nicely to this application. The cathode follower has a wide frequency response, a high input and a low output impedance. This means that the cathode follower can be used to connect a high-impedance test point to the low-impedance input of a test instrument. In a way, this is very similar to connecting an audio output tube (high

impedance) to a loudspeaker voice coil (low impedance). In this instance the output transformer of the receiver acts as the impedance matching device.

We can carry this analogy a step further. The output transformer of an audio amplifier is a stepdown device. There is always less voltage on the output side (secondary) than there is across the primary. A cathode follower behaves in the same way. The output is always less than the input when using a cathode-follower probe.

The plate of the cathode follower is at r.f. ground potential. This means that the signal currents appearing at the plate of the tube do not immediately flow through a load resistor (as in usual amplifier operation) but instead are bypassed to ground. From

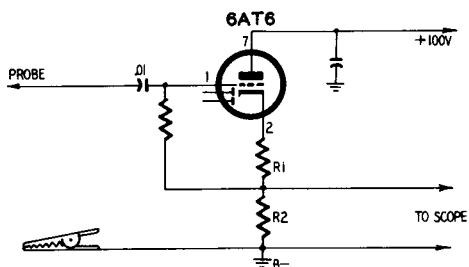

Fig. 1008. Circuit diagram of cathode-follower probe. The signal output is taken from across R2.

the ground point the signal currents flow back to the cathode of the tube. In doing so, this current, you will note, goes through two resistors. One of these (R1), is our cathode resistor and supplies bias for the tube. The other resistor (R2), also located in the cathode circuit, is our load resistor and it is across this component that the output signal voltage is developed.

Using the cathode-follower probe

The probe is very useful in circuits where the signal level is sufficiently large enough to overcome the loss in the probe. It is rather difficult to give a strict rule about this since the sensitivity of your scope will also be a determining factor. The probe can be used for testing the output of high-impedance crystal phonograph pickups, video-amplifier circuits or any circuit where faithful reproduction of the signal on the scope is important.

Grid-leak detector probe

This type of probe has the advantage of extreme sensitivity.

Unlike crystal and vacuum-tube diode types, the grid-leak detector probe amplifies the signal being tested.

The grid-leak detector probe (see Fig. 1009) can pick up the radio signal right at the antenna input of a receiver or will even give an indication of the amount of signal appearing across an ordinary piece of wire. A grid-leak detector operates as a sort of combined diode triode, with the control grid of the tube functioning simultaneously as the diode plate and also as the control grid for the triode. Hence, this probe supplies both detection (rectification of the signal) and amplification. Its chief disadvantage is that it overloads easily and distorts comparatively strong signals. The probe is ideal for use where you simply want to trace from the antenna of a receiver to the speaker and are not concerned with the quality of the signal.

The probe tube shown in Fig. 1009 is a miniature type 6AT6. The tube is used as a triode. The diode plates are connected externally and, since they are not used in the circuit, are wired to the cathode. Component values are not critical and you can substitute other values if you wish. You will find that the probe has greatest sensitivity when using a high-value resistance in the grid circuit, such as the 15-megohm unit illustrated. The 50- μf capacitor in the plate circuit bypasses any *carrier signal* that may appear at this point. A small amount of audio will be bypassed also, but not enough to be significant. The bypass capacitor in the plate circuit should be not much larger than 50 μf since you may begin to get excessive loss of audio signal.

The audio voltage appears across the 220,000-ohm plate load resistor. You can connect the output of the probe through a .01- μf capacitor to a pair of phones or to an audio amplifier.

Using the grid-leak detector probe

The probe can be used almost anywhere in a radio receiver. All you need do is go from input to output of each succeeding stage. For example, if you are tracing a signal through the i.f. stages, place the probe tip at the control grid of the i.f. tube and then at the plate of the same tube. If the signal appears at the control grid, but not at the plate, then the signal is being lost in that stage. If the signal strength at the plate is lower than that at the control grid, or if there is no apparent increase in signal strength, then the tube used in that stage may be weak or operating with incorrect potentials. Thus, the probe can be used to give you some indication of the relative gain of each stage.

If the receiver is dead, but all plus voltages seem to be normal, start at the antenna and trace the path of the signal through successive stages. The whole idea here is the same as in any other signal-tracing procedure. Narrow down the area of search until the trouble-giving component is located.

The grid-leak detector probe is sufficiently sensitive so that you can use it to trace hum. Locating a hum-causing component can sometimes be difficult and time consuming. This probe makes the job easier. Suppose, for example, that with your probe on the control grid of a tube the signal sounds clear and hum free, but that at the plate of the same tube the hum level rises seriously. Substitute the tube and examine the components of that stage.

Use the probe to check screen bypass capacitors. If your probe

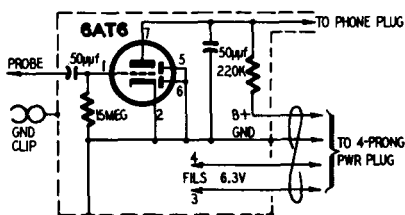

Fig. 1009. Grid-leak detector probe. Such probes are extremely sensitive, overload easily.

shows the presence of signal voltage at the screen of an r.f. amplifier or i.f. amplifier tube, the screen bypass capacitor may be open or the capacitance of the unit may not be large enough.

The probe will also help you find intermittents. Put the probe at the tube plate pin and tap the tube *gently*. If the signal changes or disappears, the tube can be suspected. With the probe at the same point, tap resistors and capacitors in that circuit. The signal should not be affected. Any component that causes the signal to fluctuate or disappear should be replaced.

Grid-dip probe

Few technicians recognize the close relationship between a grid-dip meter and a v.t.v.m. Both instruments are useful. Often both are used on the same repair project—one to measure frequency, the other to measure voltage. The two instruments are physically similar. Each requires a relatively low B supply (about 150 volts), a sensitive d.c. meter and a probe. It seems wise therefore to combine them into a single unit with separate probes for each function. The same power supply and microammeter can be used for both.

Fig. 1010 shows a grid-dip probe made to plug into a home-made v.t.v.m. The probe is housed in a 4 x 4 x 2-inch metal box into which a 7-lead cable can be plugged. The other end of the cable plugs into the voltmeter proper. When a.f. or r.f. voltage is to be measured, a voltmeter probe is substituted for the probe in Fig. 1010.

The grid-dip circuit shown in Fig. 1011 is simple and effective. It consists of oscillating circuit L-C with a plug-in coil. Power for the 955 acorn tube is supplied through the cable. Since the tube oscillates at all times, grid current flows out of lead 2. This lead connects to the microammeter in the v.t.v.m. as shown in Fig. 1012. When the grid-dip probe is used, an auxiliary switch

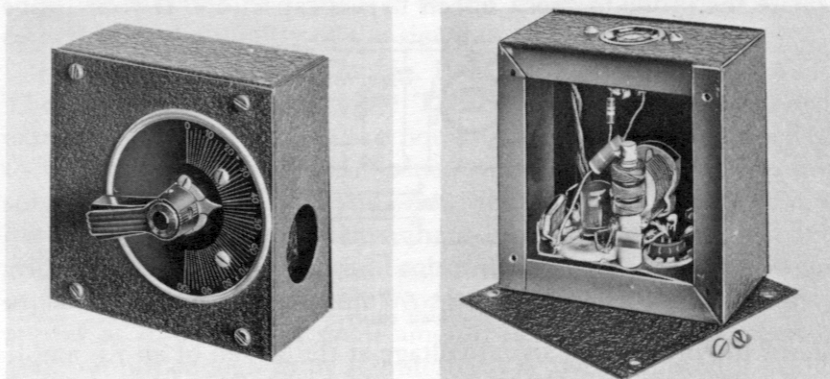

Fig. 1010. Outside and inside view of the grid-dip probe. The sides of the case are held in by self-tapping screws, are easily removed. No chassis is needed since the components can be mounted directly to the case.

removes the meter from the voltmeter circuits so it can measure the grid dip. A meter shunt is also used. This adjusts the meter to full scale.

Using the probe

The probe is simple to use. First the meter is adjusted to full scale as mentioned. Then coil L is brought near an external circuit being measured. This may be a wavemeter, an r.f. amplifier tank, an antenna (through a coupling coil), etc. When the external tank resonates with L-C, power is absorbed from it. This causes a dip in the grid current. At maximum dip the unknown frequency is read from the grip-dip calibration.

Of course the grip-dip instrument is also an excellent signal generator. Simply couple L near an r.f. receiver and listen for

zero-beat. Plenty of harmonics are available. This makes it easy to calibrate the grid-dip meter. At higher frequencies, a TV receiver helps a calibration.

Fig. 1013 shows a common type of voltmeter probe which can be used as companion to the grid-dip probe. The same lead numbers are used for the ground and filaments as in Fig. 1011. The

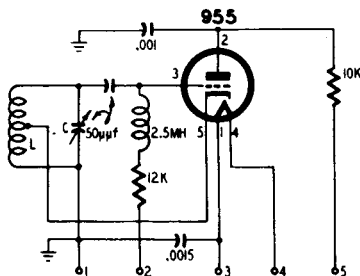

Fig. 1011. Circuit diagram of the grid-dip probe.

other two, leads 6 and 7, connect to the v.t.v.m. tube grids.

Construction is straightforward, but two points need explanation. The bottom of an acorn tube extends below its socket. Therefore the latter cannot mount directly on the metal box. Add a metal shelf $1/2$ inch below the top of the box. It holds the sockets

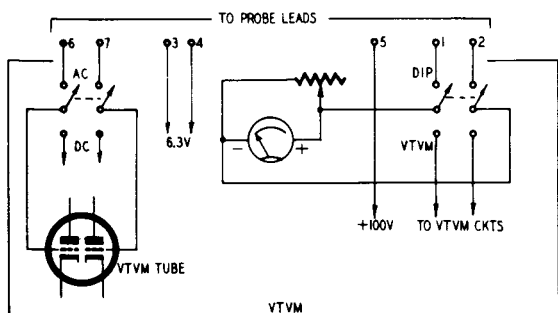

Fig. 1012. Wiring arrangement for connecting the grid-dip probe to a sensitive meter.

for coil L and the 955 tube. The shelf may be mounted either with spacers or brackets.

For high frequencies, a $3/4$ -inch diameter polystyrene coil is convenient. Be careful in soldering to the pins. More often than not the heat softens the polystyrene and ruins the coil form. Try the following procedure: Saw the base off an Amphenol type 24 form (no prongs). This form fits neatly into a 4-prong miniature

chassis plug (type 71-4S). The two are cemented together or they may be held together by screws. This makes a plug-in coil form with a bakelite base so there is no soldering problem. The chassis plug mates with Amphenol socket type 78-S4S.

Two coils are used with this probe. One has 8 turns occupying about $\frac{1}{2}$ inch. This tunes over 10 and 15 meters. The other has 4 turns and oscillates on 6 meters. Other ranges may be determined experimentally; it is difficult to specify exactly at high frequencies.

The grid-dip instrument tunes much more sharply than an absorption meter. A circuit does not have to oscillate to have its

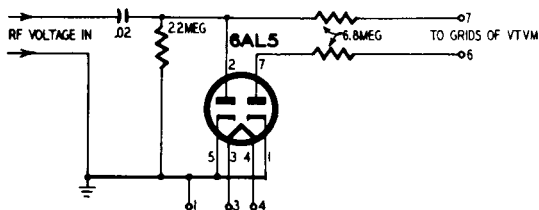

Fig. 1013. Probe for measuring r.f. voltage uses miniature 6AL5 duo-diode.

frequency measured by the grid-dip method. This offers a decided advantage. Not only must an absorption type meter depend upon an oscillator circuit to operate, but in the process a small amount of power is taken from that circuit. In cases of low-power high-Q circuits, noticeable impedance may be reflected.

Materials for probe

Resistors: 1—9,100, 1—12,000, $\frac{1}{2}$ watt.

Capacitors: 1—50 μmf , mica; 1—1,000 μmf , mica; 1,500 μmf , ceramic; 1—50 μmf , variable.

Miscellaneous: 1—2.5-mh r.f. choke; 1—955 tube and socket; 1—4-prong socket (Amphenol 78-S4S); 2—coil forms (Amphenol type 24); 2—4-prong plugs (Amphenol 71-4S); 1—metal box 4 x 4 x 2 inches; 1—7-prong socket.

Probe housing

Crystal demodulator and voltage-divider probes are somewhat simpler in their physical construction than vacuum-tube probes. Tube probes require some means for mounting and supporting the tube in the probe housing. In addition, the tube must also be supplied with filament and plate voltage. Miniature tubes are generally used.

The probe housing has a double purpose. It serves to shield

the tube from stray fields, keeping hum and noise voltage out of the probe. Since a probe has to tolerate rough usage in servicing work, the probe housing also acts to protect the tube.

You can mount the probe tube in almost any kind of metal can. You can also use plastic or some type of insulated tubing. This material will give protection, but you will lose the shielding effect. A small i.f. can, such as that shown in Fig. 1014, makes a fine probe housing. The tube that is used is a 1S5, although you can use almost any other type of miniature triode or pentode you may wish.

As shown in Fig. 1014, the tube is supported on a mounting bracket which holds the tube socket. The two ends of the bracket

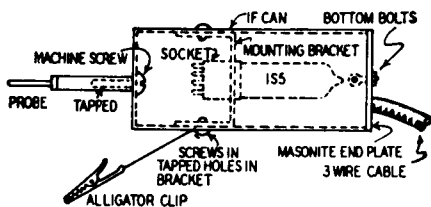

Fig. 1014. An i.f. transformer can makes a useful probe housing.

are bent at right angles. The bracket can be held in place by means of a pair of self-tapping screws. The probe tip will have to be insulated from the metal can. You can do this by inserting a prod tip in a small length of plastic rod. The other end of the rod is held to the metal can by a machine screw. You can make the required connection between the probe tube and the prod tip by running an insulated wire through one of the two holes at the top of the i.f. transformer can.

Naturally, you will have to make all of your connections before you put the tube and its mounting bracket inside the can. After you do so, place sponge rubber around the tube to minimize microphonics and to prevent damage to the tube from rough handling. Cut a piece of masonite for the bottom end plate. This can be drilled so that it can be fastened to the open end of the i.f. can with the two mounting lugs already on the can. The cable can be held in place by wrapping a few turns of steel wire around it tightly and then looping one end over one of the lugs.

Portable signal tracer

The circuit for a complete signal tracer is shown in Fig. 1015.

The probe uses a 1S5 miniature pentode (triode-connected) which can be housed in an i.f. shield can in the same manner as that described in the preceding paragraphs. With the screen and the plate of the 1S5 tied together, the tube functions as a triode detector and amplifier. The 1S5 is suited for this job since it gives good pickup gain with little distortion. The circuit is simply that of a grid-leak detector and one stage of audio amplification. Few components are used and the entire audio section plus batteries can be put into a very small case.

Using the tracer

Although the circuit is simple, you can get some surprising results. You can use it to locate weak stages anywhere from the

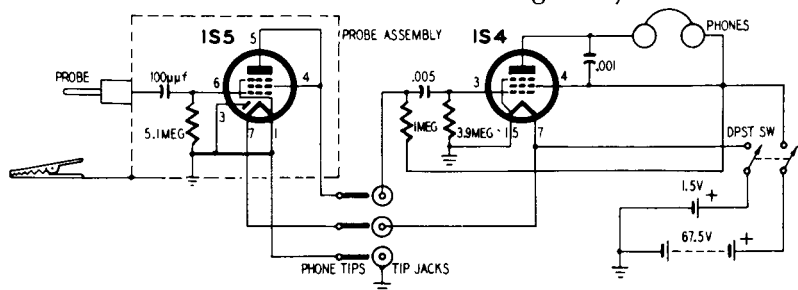

Fig. 1015. Completely self-contained signal-tracer and probe. The output of the probe feeds into a single stage audio-amplifier. A midget output transformer and speaker can be used instead of phones.

antenna to the speaker of a receiver; find defective tubes, bad coupling capacitors, open coils . . . and almost any condition you can name.

One of the tracer's biggest advantages is that no line isolation transformer is needed. Moreover, there is no bothersome interaction between the probe and the receiver. Fasten the alligator clip to the common negative or ground of any receiver and touch the control grid of the first r.f. stage or the antenna with the probe and a local station can easily be heard in the phones. Substitute a small output transformer and speaker for the phones, if you wish.

Always tune in a local or powerful station while checking the first r.f. stage because the r.f. energy here is very small. Now try placing the probe on the plate of the first r.f. amplifier (if the set has such a stage) and notice the volume. After this stage and through the rest of the receiver, the probe doesn't necessarily

have to touch the soldered contacts but can be held close to the wire carrying the signal. When checking the last one or two audio stages, it is best to have the volume turned way down on the receiver, for the signal has been amplified quite a few times and is sometimes rather loud.

Signal tracer for AM, FM and TV

In an effort to achieve simplicity and a minimum of operating controls, many signal-tracing systems use a simple demodulator probe (either crystal or vacuum-tube diode) followed by a one-or two-stage audio amplifier. For most work such a tracing

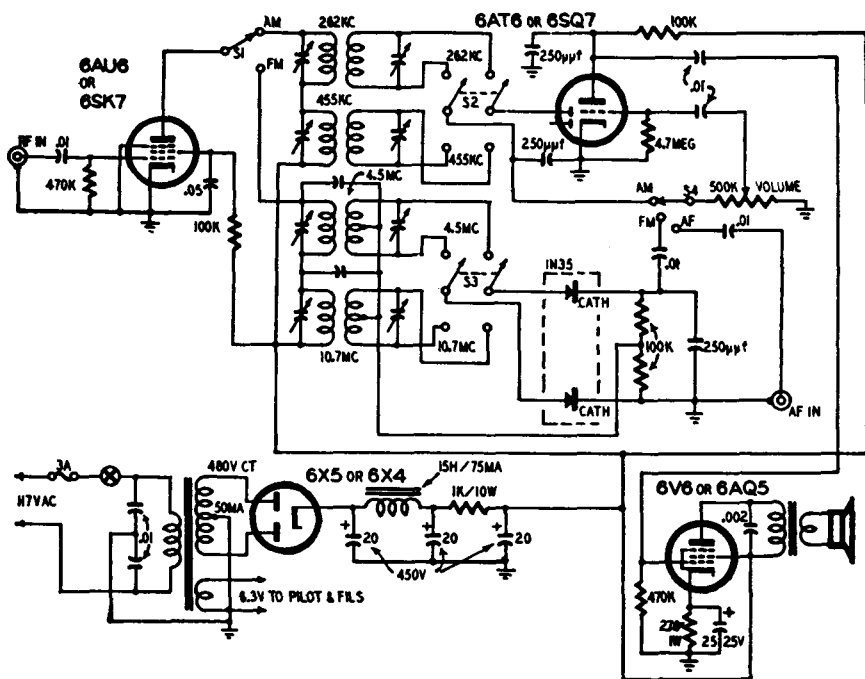

Fig. 1016. Circuit diagram of a tuned signal tracer that can be used for servicing AM, FM, and TV receivers.

system is quite advantageous, but its usefulness is limited to moderately strong r.f. signals. An amplifying probe using a triode or pentode can be used instead, but such probes (like the more simple diode probes) have no selectivity and respond to all signals.

A tuned signal tracer has a number of factors in its favor. Its sensitivity is much higher than other types of tracers and you have some control over the signal you want to examine. However, the tuned signal tracer is more complex than simple audio-

amplifier tracers and requires somewhat more care in its construction. Fortunately, the probe used with the tuned tracer can be made as compact as you wish, is easy to construct.

The probe head for a tuned tracer can consist of a pair of 2.2- μf ceramic capacitors in series. A short, low-capacitance coaxial cable should be connected between the probe and the signal tracer input circuit. For maximum versatility, you can also make up a complete set of probes for the tuned tracer, using crystals or tubes. The circuit of Fig. 1016 shows a grid-leak detector probe being used with the tuned signal tracer.

You can use the tuned signal tracer shown in Fig. 1016 for tracing signals through the i.f. circuits of FM, AM and intercarrier type TV sets. The r.f. input terminal feeds into a pentode r.f. amplifier. S1 in the plate circuit of this stage selects the primaries

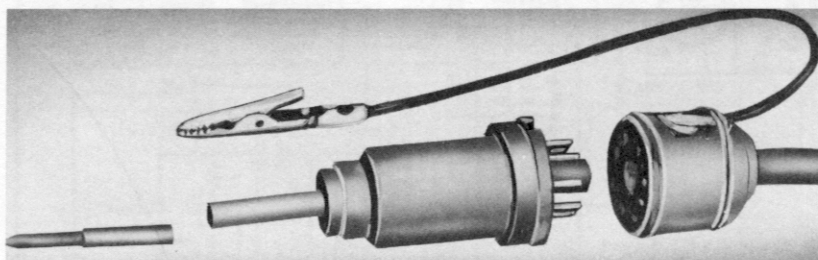

Fig. 1017. Photo of the vacuum-tube probe. The probe is very sensitive and can be used in very low r.f. signal voltage stages.

of the 262-and 455-kc AM i.f. transformers or the series-connected primaries of the 4.5-and 10.7-mc transformers. S2 selects either one of the AM i.f. transformers and connects the desired circuit to the AM detector using the diode section of the 6AT6. S3 selects the desired FM i.f. signal and feeds it to a discriminator using a 1N35 germanium duo-diode. S4 connects the volume control and the grid circuit of the 6AT6 triode to the AM or FM detector outputs or to the audio input terminal. The 6AQ5 is a conventional power-amplifier stage.

The constructor has a choice of using octal or miniature tubes. The latter type is recommended for compactness so the leads can be kept short.

Tube probe

A tube itself can be used as a probe, thus eliminating the need for mounting and supporting a tube inside a probe housing. A

metal type 6K7, although used primarily for renewal purposes in older radio receivers, makes an excellent probe tube. The fact that the tube is practically obsolete for modern radio design work does not mean that it cannot be used as a probe.

A picture of the tube probe is shown in Fig. 1017. Start with a 6K7, a 6F5 or almost any other metal tube which has a grid cap on top. Cut a piece of 1/4-inch copper tubing about 7/8 inch long. Solder it directly to the grid cap.

The circuit diagram of the probe and an associated, simple audio stage is shown in Fig. 1018. The probe requires a small input capacitor and a grid leak. You will find it much more convenient to make these two radio components than to mount and support a typical capacitor and resistor.

To make the input coupling capacitor, take a piece of No. 10 copper wire about 1 1/2 inches long. File one end to a point. Wrap

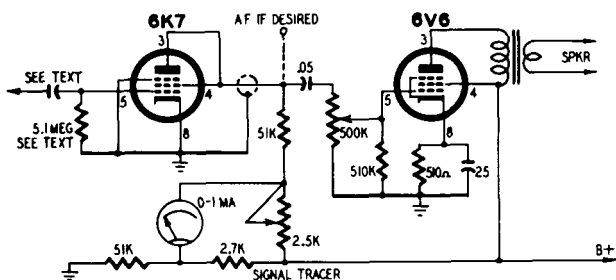

Fig. 1018. Circuit of the vacuum-tube probe. The 0-1 ma meter is a useful feature, but can be omitted if desired.

the other end with a 1-inch strip of waxed paper, allowing the paper to overhang the end of the wire slightly. When enough paper has been added for a tight fit, force the wrapped end of the wire into the copper tubing (previously soldered to the grid cap of the tube) and you will have your input capacitor.

Making the grid resistor is still easier. Using a knife, scrape the paint from the edge of the metal tube cover where it is crimped over the piece of bakelite at the top end of the tube. Now take a pencil and mark all over the bakelite, covering the entire surface between the metal edge of the top of the tube and the copper tubing connected to the grid cap. Rub the pencil graphite in well with your finger. Repeat the process once or twice, and you have formed the grid leak. If you do not care to use this type of resistor, you can always solder a small 1/2-watt resistor from the grid cap to the metal casing of the tube.

For convenience in changing tubes the probe tube is simply plugged into an 8-pronged female cable connector to which the lead-in cable is connected. The lead-in cable should contain a shielded plate lead, a ground wire (or the shield can be used for this since it must also be grounded) and one filament lead.

The values shown in the meter bridge circuit should be closely followed. A 1-ma meter is preferred for sensitivity. Before use, the meter is adjusted to zero (while the probe tip is grounded) with the 2,500-ohm potentiometer. Thereafter, any input signal picked up by the probe will be indicated by the meter. If the signal contains audio components, they can be heard from the speaker.

The audio stage consists of a volume control, a 6V6 (or any other good output tube) and a 3-inch PM speaker.

In receiver trouble shooting, the ground clip on the probe is fastened to the receiver chassis. An input signal (such as a local station or an oscillator signal) can then be traced right from the antenna coil through each stage to wherever it stops.

Shield for tube probe

When using the tube probe for work in very low signal level circuits such as the antenna input to a receiver, it may be necessary to have the volume control of the audio section set for fairly high gain. Under such circumstances, simply touching or holding the probe tube in your hand may produce hum, noise, or some sort of undesired signal pickup. You can avoid such situations by putting the tube probe in a shielded container.

One way of doing this is shown by the illustration, Fig. 1019. The tube is mounted inside the shield and a wire is run from the control-grid cap of the tube to an input jack mounted at the top of the shield. The input jack can be of the type which will accommodate a needle point (such as used in test prods) or may be a short length of stiff wire or bus, force fitted into the jack. The grid capacitor and leak are mounted inside the shield can. The tube can be mounted in a socket and the wires of a cable connected to the socket pins or else you can use an octal type male-female connector assembly.

The outside metal shield should be connected to the shield pin of the tube. The shield pin is the number 1 pin on the socket. It is important to make this connection to get full shielding effect of the metal tube and the shield. The number 1 pin should be wired to the shield braid of the output cable and this in turn

should connect to the chassis of the signal tracer unit.

If, in operation, the metal shield becomes warm, drill a few holes in it to allow for air circulation and dissipation of the heat.

Transformer or transformerless?

A probe is a connecting link between the receiver on the bench and some piece of test equipment. In most instances, the ground side of the test instrument must be connected to the ground side of the receiver being checked. Neglecting to do this will most often produce incorrect and unstable readings on your v.t.v.m. or scope.

This requirement for having a common ground between receiver and test equipment is easily and readily done if the receiver and test equipment are both powered by transformer-type power

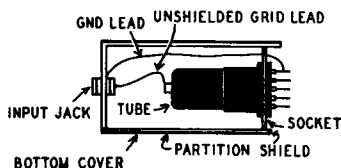

Fig. 1019. Method for shielding tube probe.

supplies. However, many receivers, both AM and TV, are of the a.c.-d.c. or transformerless type. Such receivers may or may not have a hot chassis. The hot chassis types have one side connected to the power line. The possibility of having hot-chassis sets to work on makes a line-isolation transformer at the service bench essential, to avoid the possibility of shock, due to the operator touching the chassis while standing on a damp floor, touching a conduit, pipe, or other ground path.

Transformerless receivers should always be powered by a line isolation transformer. The auto-transformer type of unit is unsuitable and will not isolate the receivers—separate primary and secondary windings must be provided.

Using a line-isolation transformer also protects the test equipment. Instrument cases are usually grounded to avoid minor shocks to the operator when he touches the metal portions of the equipment. Minor shocks result from the use of shunt capacitors in the line filters of the test instruments; these line-filter capacitors conduct a small current, sometimes sufficient to be felt by the

operator. Hence it is common practice to ground the instrument cases.

Since the instrument cases are grounded, connecting the instruments to a hot-chassis circuit can result either in blown fuses, or in burned-out components in the instruments. The line-isolation transformer prevents such damage.

Rapid servicing with probes

For servicing rapidly with probes you must know just what each type of probe can do, and just where in a circuit you should apply a particular probe. This means that you must have an understanding of radio and TV circuits and, how they function. However, for speedy servicing you must also be able to identify quickly the various circuits exposed by the under side of a chassis.

The technician should learn to look for various "landmarks" as soon as the receiver chassis is placed on the bench. Some of these are the peaking coils in the video-detector circuit, which are suitable points for probe connection in i.f. alignment; and the mixer tube, a suitable point for capacitive injection of the sweep signal into the i.f. input circuit.

The a.g.c. bus, to which the d.c. returns are made from the grid circuits of the i.f. amplifier tubes, usually can be located without using a circuit diagram for the receiver. Most of the present-day tubes used in i.f. amplifiers have pin 1 as the control grid, and unless unfamiliar i.f. transformers are used in the receiver under test, it is easy to pick out the return point of the grid circuit, which identifies the a.g.c. bus. Fixed d.c. bias should be applied between the a.g.c. bus and chassis ground to stabilize i.f. amplifier operation during alignment and to set the gain at a suitable point.

When the front end is of a familiar type, the local-oscillator tube can be quickly located. In the majority of cases, the technician will reach for a dummy oscillator-mixer tube which he has made up.

The output of the video amplifier is usually easy to locate, also; it consists of the final pair of peaking coils in the signal-circuit line-up, and the output from this set of coils is fed to either the grid (green lead) or to the cathode (yellow lead) of the picture tube. Although the video amplifier is not always checked during an alignment job, complaints of poor picture quality are sometimes traced to this section.

television waveforms

Throughout this text we have tried to show some examples of the many waveshapes the technician will encounter in servicing receivers. It is very important for you to know, however, that because of the varying characteristics of chassis, probes and test equipment, waveshapes as seen on the scope can vary greatly.

For example, the horizontal sync pulse and the vertical sync pulse at the video stage of a properly adjusted TV chassis will have exactly the same height when pictured on a *broad-band laboratory type* scope through the use of a 10-to-1 capacitance-divider probe. When a lower-priced service scope is used, however, the vertical sync pulse may have greater vertical amplitude than the horizontal sync pulse. This condition results from the fact that the lower-priced scope may attenuate the height of the horizontal sync pulse (15,750 c.p.s) which is of much higher frequency than the vertical sync pulse (60 c.p.s.).

Waveshapes will vary not only with a change in testing instruments but also from TV chassis to TV chassis. Even using the same scope and probes, the technician will encounter different waveshapes as he tests similar circuits. Service technicians should spend as much time as possible, therefore, in getting acquainted with test instruments and with the waveshapes of the more popular TV chassis.

It is good servicing technique to use a scope and probes to trace the signals throughout the different stages of a properly functioning TV chassis. You should make it a point to view wave-

shapes of circuits peculiar to each popular chassis. As you make such a study, sketch the waveshapes for future reference. Once you have on paper a representation of the waveshapes of a properly functioning TV chassis, you will have a basis of reference when servicing these receivers.

Each chassis and model of the same manufacturer will have waveshapes which will deviate somewhat from a typical sample for this particular chassis because of modifications in receiver components and because of production adjustments. We suggest, therefore, that the service technician make waveshape sketches of two or three different chassis of each model to get acquainted with the variations that may be expected.

With the scope and probe the technician can make measurements that are absolutely impossible with any other known technique. The value of this knowledge is completely dependent upon your ability to interpret what you see on the scope. Efficiency in the use of the scope and probes will depend entirely on acquaintance with waveshapes encountered in servicing TV receivers.

The same reasoning applies to the measurement of d.c. voltages. Voltages at various test points in a receiver will depend upon the sensitivity of your test instrument and the circuit in which the checks are being made. For example, in a high-impedance circuit the voltage indicated on your test meter might actually be lower than the operating voltage.

Television waveforms

It might very well seem to the service technician that because of the many variables involved, servicing by waveform inspection would be a hopeless task. You can reduce it from the status of a guessing contest by keeping a record of waveforms you have observed and also by comparing the waveshapes with those seen on a wideband laboratory type scope. The illustrations that follow were taken from a representative, modern TV receiver using a scope designed to show the waveshapes as they actually exist. By using these illustrations as a guide you will be in a better position to interpret what you see on your own scope.

Waveforms in TV receivers

Interpretation of waveforms is not always an easy matter. When an auxiliary receiver is available, comparison checks can be made back and forth between the faulty receiver and the normal receiver. When an auxiliary receiver is not available, the technician may have trouble because of the incompleteness of the published data. In many cases the waveform and peak-to-peak voltage may check out correctly, but the circuit action will still be faulty because of minor spurious components in the waveform.

Whether or not such minor spurious components are tolerable cannot be determined when the published waveforms are sketched rather than photographed; the technician making the sketch almost always deletes minor components which may be present in normal operation.

In Fig. 1 we have the setup in progress for the examination of waveforms in a TV receiver. The receiver is attached to the scope through the probe. In this picture, the low-capacity probe is being connected to the sync separator. The scope (Tektronix 524D) is set to external sync and is connected to the output of the integrator. The receiver is a Magnavox, series 105. Most of these pictures were taken with this equipment. Figs. 13, 14, 16, 22 and 23 courtesy of G-E Techni-talk.

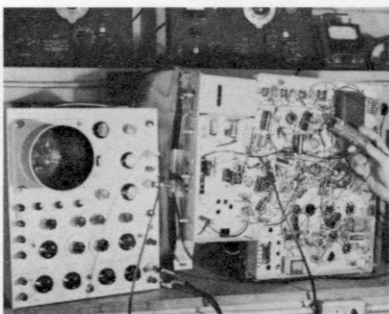

Fig. 1

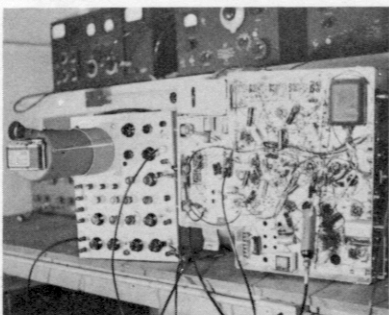

Fig. 2

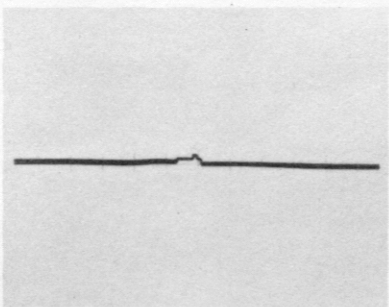

Fig. 3

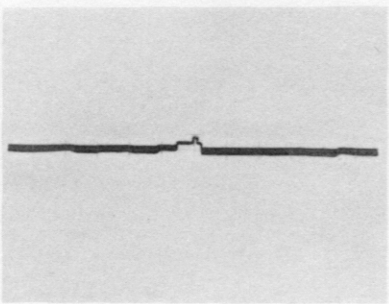

Fig. 4

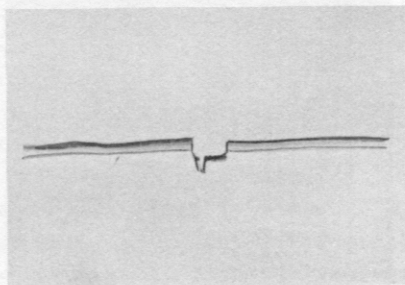

Fig. 5

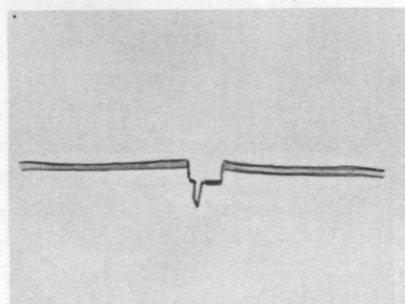

Fig. 6

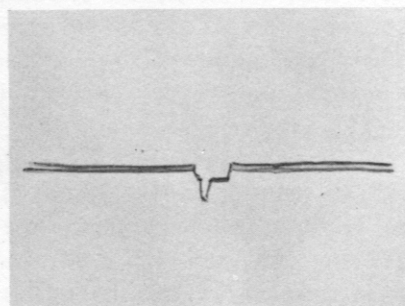

Fig. 7

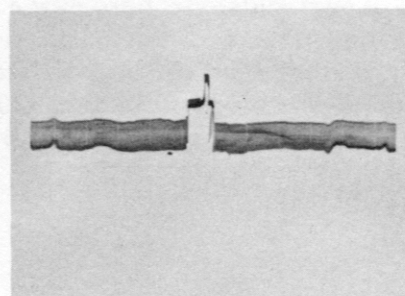

Fig. 8

When the desired waveform is obtained, the probe is kept in place by means of a clip which slips on to the probe tip. The 35-mm camera and its housing are then placed over the face of the scope. The only light for the film comes from the scope. A small viewer allows examination of the scope trace up to the moment the picture is taken. In this picture (Fig. 2) sync amplifier waveshapes are being checked.

The photo in Fig. 3 shows the output of the v.h.f. tuner (control grid of the first video i.f. stage). The probe used here is a crystal-demodulator type.

Fig. 4. Output of the v.h.f. tuner taken at the control grid of the first video i.f. stage using a crystal-type voltage-doubler probe. Note the higher deflection.

Fig. 5. The probe is now at the plate of the second video i.f. tube. In examining TV waveforms, set the scope sweep for 30 c.p.s. and then readjust the sweep for 7,875 c.p.s. These figures represent one-half the vertical and horizontal oscillator sweep frequencies in the TV set.

Fig. 6 shows the plate of the second video i.f. tube as viewed with a voltage-doubler probe. Note the higher deflection voltage that this probe gives. This is particularly useful when checking weaker or smaller peak-to-peak voltages. Voltage-doubler probes (crystal type) are described beginning on page. 51

In Fig. 7 we have the waveform at the control grid of the third video i.f. Note difference in amplitude between this wave and that shown in Fig. 3. Since we are working our way toward the picture tube, the amplitude of the waveform is increasing. The probe used here is a crystal demodulator type.

Fig. 8 shows the waveform at the plate of the third video i.f. The vertical sync pulse has a greater peak-to-peak amplitude than the horizontal sync pulses. This is due to the attenuation of the high-frequency response by the cable and scope input capacitance.

Fig. 9 shows the signal as it appears across the detector load resistor. In this instance the signal had a value of 2.6 volts peak-to-peak. The scope sweep was set to 30 c.p.s.

In Fig. 10 we have the composite video signal. Note the relative amplitude of the blanking and sync pulses, and picture component. The horizontal sync pulses have the same peak-to-peak value as the vertical-sync pulses. Because of the limited high frequency response of some service scopes and because of the high-frequency attenuation due to the capacitance of the scope cable, the high-frequency horizontal sync pulses and video component usually appear much lower in amplitude than the lower frequency vertical pulses.

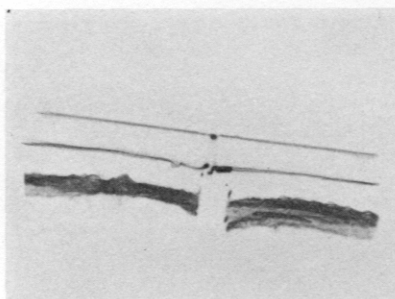

Fig. 9

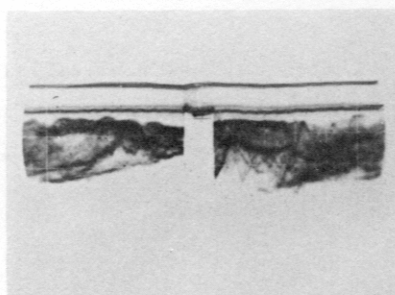

Fig. 10

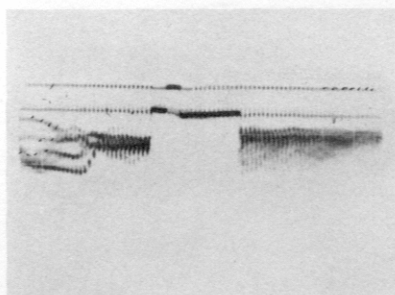

Fig. 11

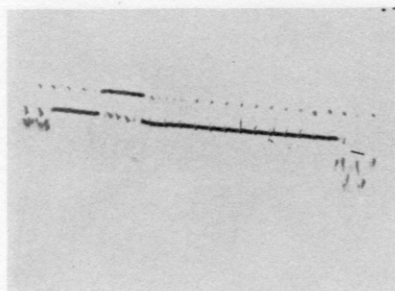

Fig. 12

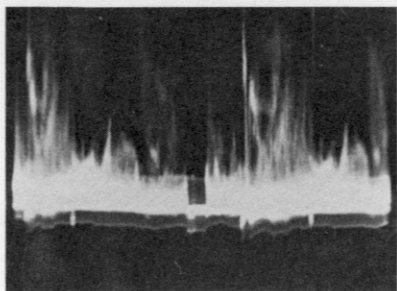

Fig. 13

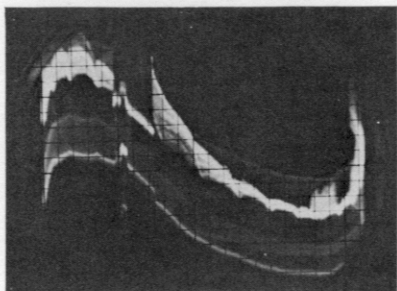

Fig. 14

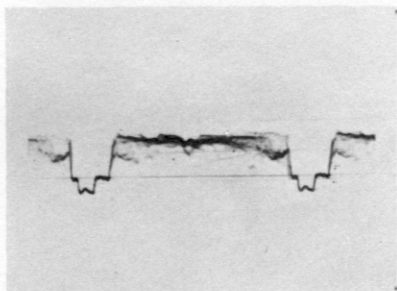

Fig. 15

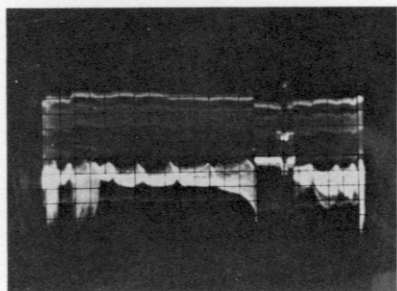

Fig. 16

Fig. 11 is the same illustration as Fig. 10, except that the waveform has been expanded three times. Note that the pulses can now be defined instead of appearing as two solid lines.

Fig. 12 is the same as Fig. 10, except that the waveform has now been expanded ten times. The horizontal sync pulses are spaced wider than the equalizing pulses. Note that the vertical sync pulse consists of six separate pulses at the equalizer pulse rate.

Fig. 13 shows a defective video signal. The sync pulses are highly compressed. Lack of stability in the vertical and horizontal sweep circuits should now be checked back through the video amplifier and picture detector stages.

Fig. 14 shows 60-cycle hum pickup in the video signal. Make sure that the hum modulation actually exists in the receiver, that it is not due to hum pickup in the test leads and that the scope is properly connected and grounded.

Fig. 15 shows the waveform as it appears at the control grid of the first video amplifier. The horizontal sync pulse is generally visible only with a laboratory-type scope.

In Fig. 16 we have another picture of the composite video signal. This is the waveform as seen in the output of the video amplifier. If the sync pulses have full amplitude here but you have vertical or horizontal instability, trace the pulses through the sync separator and amplifier circuits.

Fig. 17 shows the waveform as it appears at the plate of the first video amplifier. The waveshape contains vertical and horizontal sync pulses, plus video information. The amount of voltage depends on the strength of the TV signal. Some receivers use an additional video stage to build up the composite video signal.

The input signal to the control grid of the sync separator (see Fig. 18). The signal contains vertical and horizontal sync pulses and still carries the video information. The sync separator removes that part of the composite video signal below the blanking level.

In Fig. 19 we have the pulse at the plate of the sync clipper. The pulse is 22 volts peak-to-peak. The scope sweep was set for 7,875 c.p.s.

In Fig. 20 we have the signal as it appears at the plate of the sync amplifier tube. The video portion of the signal has been stripped away, leaving the vertical and horizontal sync pulses. These pulses will be separated by integrating and differentiating networks.

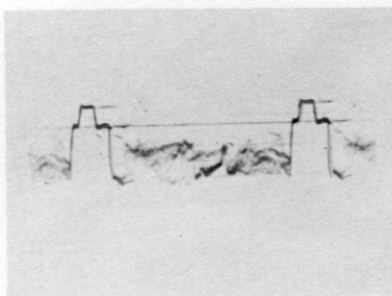

Fig. 17

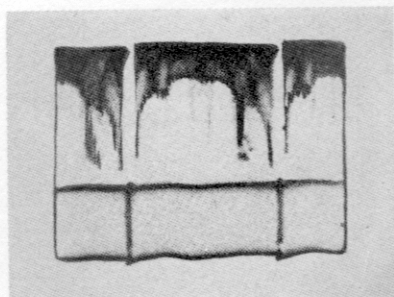

Fig. 18

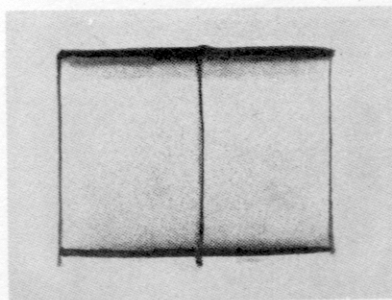

Fig. 19

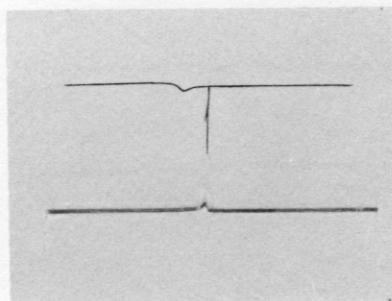

Fig. 20

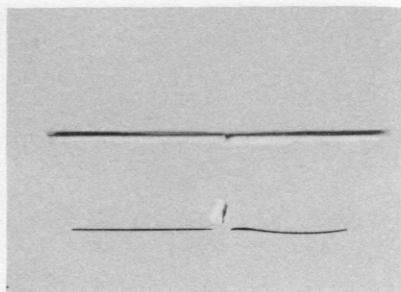

Fig. 21

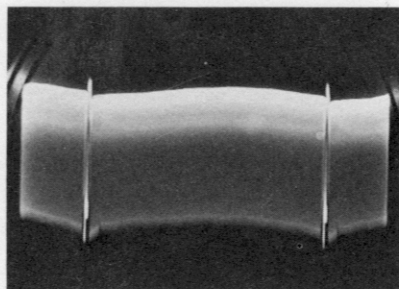

Fig. 22

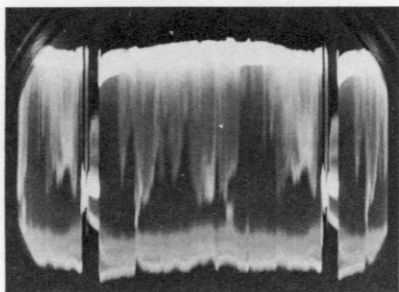

Fig. 23

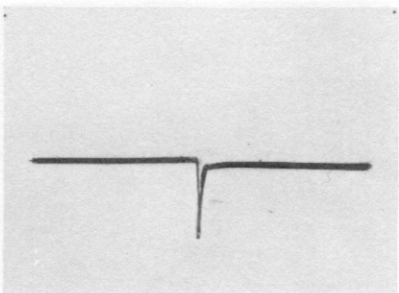

Fig. 24

Fig. 21 illustrates the wave at the cathode of the sync clipper. Here the pulse is 2.5 volts peak-to-peak. Scope sweep set for 30 c.p.s.

In Fig. 22 we have a normal sync waveform. For proper triggering of the vertical and horizontal oscillators, the sync pulses should be well clipped and free of video information.

Sync pulse output showing some video information remaining is illustrated in Fig. 23. The presence of the video signal indicates poor operation of the sync separator or clipper and results in poor synchronization.

In Fig. 24 we have the vertical sync spike at the output of the integrator network. The integrating network is a low-pass filter, has a relatively long time constant. The output of the integrating network is used to trigger the vertical oscillator.

Fig. 25. This shows the waveform at the plate of the vertical multivibrator.

Fig. 26. Waveform as it appears at the plate of the vertical discharge tube. Note the square wave component at the beginning of the sawtooth.

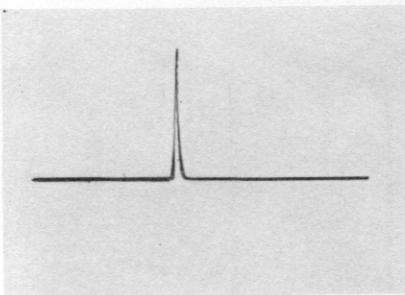

Fig. 25

Fig. 27. Waveform at the control grid of the vertical output tube. Note the presence of the square-wave component at the beginning of the sawtooth. This voltage is 18 volts, peak-to-peak, scope set at 30 c.p.s.

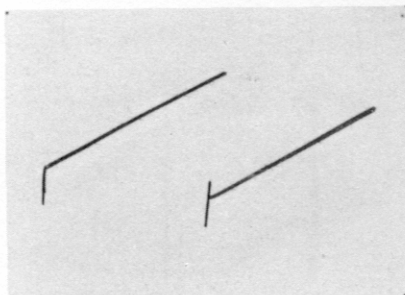

Fig. 26

Fig. 28 shows the waveform at the plate of the vertical output tube. Note that the square wave component is now much greater than that shown in Fig. 26 and Fig. 27. This is introduced purposely to correct for the reactance of the vertical-output transformer and the deflection yoke. The pulse is 750 volts peak-to-peak. Scope is set to 30 c.p.s.

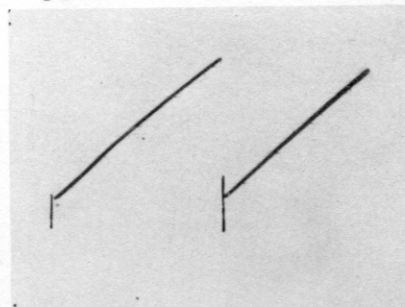

Fig. 27

In this illustration (Fig. 29) we have the waveform as it appears at the yellow lead of the vertical deflection coil. This wave is 120 volts peak-to-peak. The scope is set for 30 c.p.s.

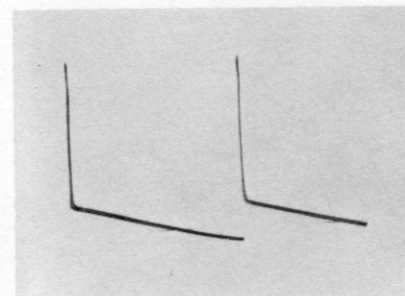

Fig. 28

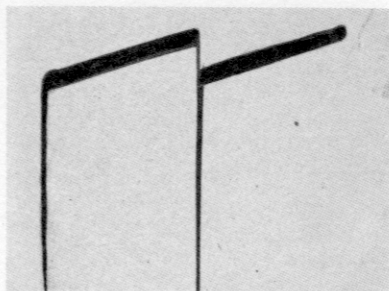

Fig. 29

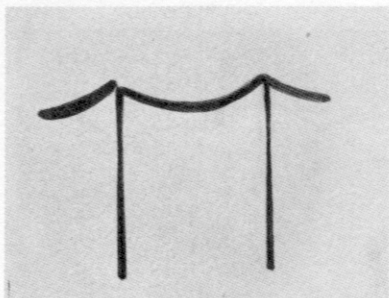

Fig. 30

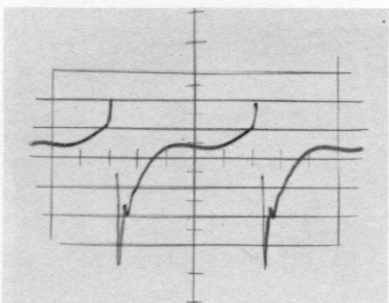

Fig. 31

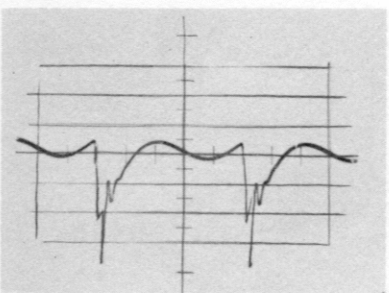

Fig. 32

Fig. 30 shows the vertical trace blanking waveform. This wave was observed at the control grid of the picture tube. In this instance the cathode of the picture tube was the signal electrode. The waveform is 12 volts peak-to-peak. Scope sweep is set at 30 c.p.s.

This illustration (Fig. 31) shows comparison voltages between the horizontal oscillator and sync spike. The sync spike is sharp. Adjustment to the speed coil should be made only when on transmitting sync. Assuming normal operation of the TV receiver, the waveforms on these pages often do not appear as shown. This is a function of the type of scope and cable that are used.

Fig. 32 is essentially the same as the waveform illustrated in Fig. 31. The decreased amplitude is due to a lower setting of the attenuator control of the scope. When examining waveforms on your scope try to get the wave at the center of the screen. A certain amount of distortion may appear in the wave when it is at the extreme left or right hand side of the scope tube.

Sawtooth in the input circuit of the horizontal amplifier is shown in Fig. 33. It is permissible to have certain nonlinearity at the beginning and end of the sawtooth, often purposely introduced to compensate for the reactance of the deflection coils in the yoke.

In Fig. 34 we have a photo of the sawtooth input to the control grid of the horizontal output tube. This waveform is exactly the same as that shown in Fig. 33 except that the vertical gain control of the scope was not advanced quite as much. This shows clearly how dependent the waveshape is upon settings of the scope controls.

Fig. 35 shows the waveform at the plate of the horizontal output tube. An ideal waveshape would be a single spike, but this is seldom found. The peak pulse usually ranges from 3 kv to 6 kv.

Fig. 36 shows pulses as they appear at the plate of the a.g.c. amplifier tube. Note that this photo has considerable resemblance to the waveform shown in Fig. 35. The pulses at the a.g.c. amplifier plate have a frequency of 15,750 c.p.s. and a peak-to-peak amplitude of about 450 volts. Scope set at 7,875 c.p.s.

In the photo, Fig. 37, we have the waveform showing the input to the horizontal deflection winding of the yoke. Note the absence of ringing transients which could be introduced by the yoke due to an impedance mismatch.

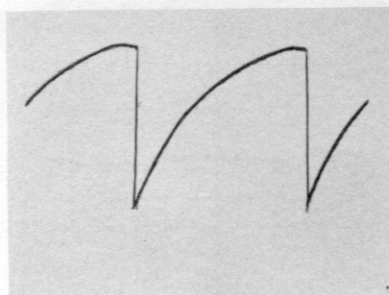

Fig. 33

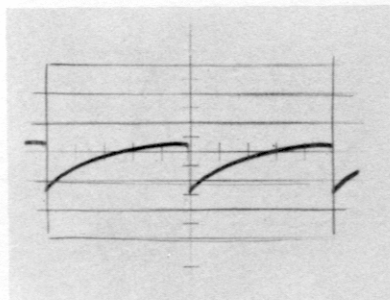

Fig. 34

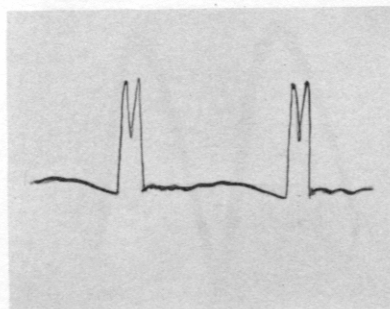

Fig. 35

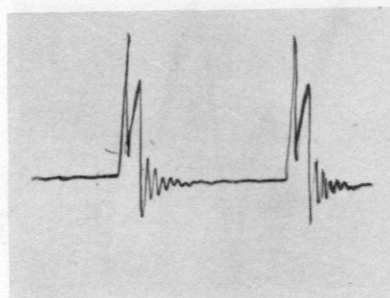

Fig. 36

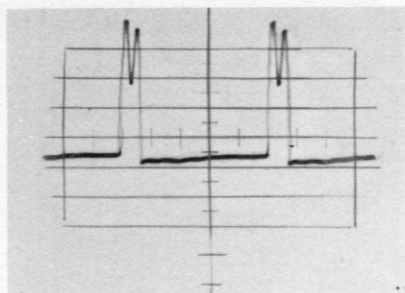

Fig. 37

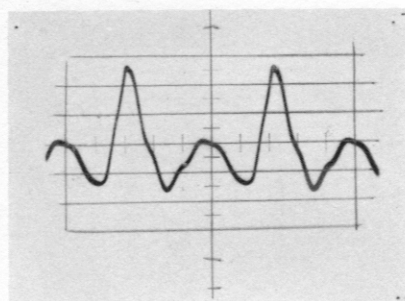

Fig. 38

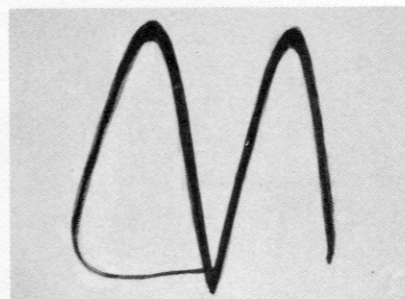

Fig. 39

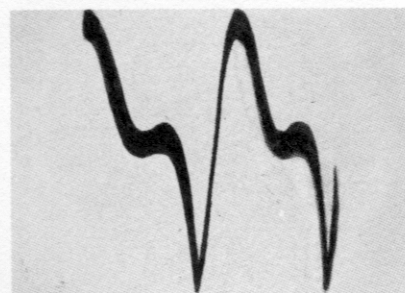

Fig. 40

Fig. 38 shows the waveshape as it appears at the plate of the damper tube. The damping tube prevents continuation of transient oscillations in the horizontal output sweep circuit. Most damper tubes are diodes although triodes are used occasionally. The vertical deflection system generally uses resistive damping.

The waveform at the cathode of the damper tube is shown in Fig. 39. Here the waveform is 50 volts peak-to-peak. The scope sweep is set for 7,875 c.p.s.

Fig. 40 shows the horizontal linearity output. The waveform is 40 volts peak-to-peak. Scope sweep was set at 7,875 c.p.s.

Accuracy, Marker	42	Blocking Oscillator Bias	127
Action of Crystal Detector	26	Blocking Oscillator, Testing the Vertical	91
Adapter, High-Voltage	95	Body Capacitance	48
Adjustable Inductors in Color TV	172	Booster Gain and Response	72
Adjusting a Video Amplifier	38	Building a Low-Capacitance Probe	96
Adjusting the Low-Capacitance Probe	87	Buzz:	
Adjusting TV Linearity	94	High Voltage	110
Advantages of Crystal Probes	23	Pulse in Sound I.F. Strip, Tracing	33
Advantages of Detector Probes	8	Sixty-Cycle	33
A.F. Tracer Probe	144	Sync	55
A.F.C., Testing Horizontal	90	Tracing Sync	54
Alignment, I.F.	29	Cables:	
Allowing for Scope Distortion	83	Miscellaneous, Using Probes with	106
AM, FM, & TV, Signal Tracer for	201	Standing Waves on	30
AM Receivers, Signal Tracing in	189	Termination of	42
AM Signal Tracer	201	Calculating Probe Resistance	116
Amplifier:		Calibrating a Marker Generator	42
Adjusting a Video	38	Calibration:	
Chroma	172	Effect of Probe on Meter	125
Chromatic	177	Marker Generator	54
Output, Video	35	Scope	83, 84
Overloading Scope	45	Capacitance:	
Probe	143	Body	48
Testing Video	35	Divider Probe	99
Waveform, I.F.	29	Of Video Amplifier, Shunt Probe	38 26
Amplifiers, Shunt Capacitance of Video	38	Probe Input	12
Asymmetrical Waveshapes	20, 86	Shunting Effect	75
Attenuation:		Capacitor:	
Factor	76, 87	Tester Probe	140
Factor of Probe, Checking	105	Tester Probe, Using the Tube Used as a	142 100
Measuring Probe	76	Capacitors, Testing Intermittent	140
Probe	75	Cathode-Follower:	
Audio Tracer:		Gun Probe	160
Probe	137	Probe	192
Using the	138	Probe, Using the	193
Back Current	37	Channel, Y	171
Balanced Input	73	Characteristic Impedance	48
Balanced Probes	59	Characteristics:	
Balanced Probes, Construction of	70	Demodulator Probe	10
Balun	69	Probe Filter	11
Balun, Coaxial	73	Response	14
Base Line, Zero Volt	44	Checking Output of Sweep Generator	44
Beat Marker	41	Checks, Color Circuit	179
Beats:		Chroma Amplifier	172
Interharmonic	43	Chromatic:	
Major	43	Amplifier	177
Minor	43		
Bias, Square Wave, for Sweep Oscillator	65		
Bias, Vertical Blocking Oscillator	127		

Probe	165	Input Capacitance of	12
Probe, Flatness of	177	Input Voltage to the	12
Probe, Maintenance	174	Maximum Input to	10
Probe, Using the	168	Radio Servicing with	26
Chrominance Circuit, Low Frequency		R.F. Input Voltage to	12
Response of	174	Demodulators, Series and Shunt	10
Circuit Checks, Color	180	Design of 100-to-1 probe	100
Circuit Loading	75	Designing Low-Capacitance Probe	78
Circuits:		Detection	26
Checking High-Voltage	109	Detector:	
Resonant, Detuned by Probe	187	Action, Crystal	26
Sweep	111	Curve, Marking a Ratio-	41
Sync	112	Probe, Grid Leak	193
Coaxial Balun	73	Probes	8
Coaxial Cable, Termination of	48	Probes, Crystal	7
Coil, Tuned Probe	34	Probes, Using	8
Coils in Color TV, Adjustable	172	Response, I-Channel	
Coils, Testing Deflection	93	Synchronous	170
Cold Spots	48	Response, Q-Channel	
Color:		Synchronous	170
Circuit Checks	180	Detectors, Series and Shunt	10
Intensity Control	172	Development of Wide-Band Sweep	166
TV, Adjustable Inductors in	172	Diode Current	36
TV Testing	55, 169	Diode Voltage Ratings, Crystal	36
Combined Direct and Isolation		Direct Probes	123, 130
Probe	132	Direct and Isolation Probe,	
Common Ground for Test		Combined	132
Instruments	49	Direct Probes, Using	131
Compensation, Frequency	87	Distortion:	
Component, D.C., High	82	Allowing for Scope	83
Composite Video Signal Distortion	29	Composite Video Signal	29
Connectors	156	Phase	39
Constructing a 100-to-1 probe	102	Standing Wave	48
Construction of Isolation Probe	124	Undershoot	28
Contact Potential	12, 183	Divider Probes	105
Control, Color Intensity	172	Doubler Probe, Grounding the	
Coupling Efficiency	72	Voltage	53
Crossover S-Curve	42	Effect of Probe on Meter Calibration	125
Crystal:		Effects of Ground Current	20
Demodulator Probes	7	Efficiency of Coupling	72
Detector Action	26	Efficiency of Sync Discriminator,	
Diode Current Ratings	36	Testing	90
Diode Voltage Ratings	36	End, Load	59
Impedance	21	Erratic Operation	20
Probe Frequency Range	12	Errors, Waveform	46
Probe Requirements	11	Extending Voltage Range of Probe	90
Probes, Advantages of	23	Factor, Attenuation	76, 87
Probes, Measurements with	21	False Markers	28
Probes, Servicing with	25	Feedback	55
Voltage, Peak	23	Feedback in Probe	192
Current:		Feedback Stage	28
Back	37	Filter Capacitance of Probe	26
Grid	29	Filter Characteristics	11
Rating of Crystal Diode	36	Finding the Beat Marker	41
Yoke	93	Flatness of Chromatic Probe	177
Curve, Crossover S-	41	Flatness of Probe	11
Curve, Marking a Ratio-Detector	168	Flatness of Lead-In	61
Curves, Obtaining Video Response	148	Flyback Defects, Spotting	108
Cycle, Sixty, Rejection	57	Flyback Transformer, Excessive	
D.C.:		Reactance in	108
Component, High	82	FM Receivers, Signal Tracing	190
Output of Probe	184	FM Signal Tracer	201
Output Vs. Peak Voltage	185	Frequencies, Input Impedance at	
Probe	124	High Channel	47
Voltage at Video Amplifier Input	169	Frequencies, Square-Wave	
Voltages, Measuring	127	Generator	40
Dead Stage, Indication of	55	Frequency:	
Dead Stage, Locating a	30	Compensated Probe	143
Defects, Spotting Flyback	108	Compensation	87
Deflection:		Range of Crystal Probe	12
Circuits, Horizontal	111	Response	56
Coil Current	93	Response of Chrominance	
Coils, Checking Horizontal	81	Circuit	174
Coils, Testing	93	Gain, I.F.	29
Delay Line, Ringing	171	Gain of Boosters	70
Delay Time	39	Gain Per Stage	28
Demodulation	26	Generator:	
Demodulator Probe:		Cable, Termination of	48
Characteristics of	10		
Crystal	7		

Calibrating a Marker	42	Matching Pads	30
Frequencies, Square-Wave	40	Matching Transformer	69
Impedance	73	Mismatch	61, 69
Locking	175	Transmission Line	66
Marker, Calibration of	54	Indication, Dead Stage	55
Sweep, Checking Output of	44	Indicator Probe R.F.	149
Generators, Harmonics of	43	Inductors in Color TV, Adjustable	172
Grid:		Input:	
Current	29	Balanced	73
Dip Probe	195	Capacitance of Demodulator	
Dip Probe, Using the	196	Probe	12
Leak Detector Probe	193	Impedance at High-Channel	
Leak Detector Probe, Using the	194	Frequencies	47
Ground:		Resistance of Multitester	126
Current Effects	20	Resistance of V.T.V.M.	124
Leads	186	R.F. in Scope	45
Leads, Importance of Short	46	Scope, Requirements of	16
Returns	46	to Demodulator Probe,	
Grounding	186	Maximum	10
Grounding Instruments	49	to Scope, Voltage	16
Grounding the High-Voltage Probe	114	to Voltage-Doubler Probe	52
Grounding the Probe	20	Voltage Limitation of Voltage—	
Grounding the Voltage-Doubler		Doubler Probe	52
Probe	53	Voltage, R.F., to Demodulator	
Grounds	186	Probe	12
Gun Probe, Cathode Follower	160	Instruments, Grounding of	49
Gun Probe, Transistorized	162	Insulation	11
Handling Probes	135	Intensity Control, Color	172
Harmonics	43	Interchangeability of Probes	23
Hash	14	Interharmonic Beats	43
Heterodyning	43	Intermittent Capacitors, Testing	140
High-Channel Frequencies, Input		Intermittents	195
Impedance at	47	Inverse Feedback in Probe	192
High-Frequency Probe	184	IRE Roll-off Characteristic	83
High-Frequency Voltages,		Isolation and Direct Probe,	
Measuring	184	Combined	132
High-Impedance Circuits, Use of		Isolation Probe:	
Low Capacitance Probe in	79	Construction of	124
High Voltage:		for Scope	128
Adapter	95	for V.T.V.M.	123
Buzz	110	Reasons for Using	123
Circuits, Checking	109	Time Constant of	129
Circuits, Use of Probe in	81	Isolation Resistor	123
Multiplier Probe	115	Lead-In Flatness	61
Probes	99	Leads:	
Probes, Grounding	114	Ground	46, 186
Probes, Using	107, 116	Test	134
Rectifier, Behavior of Probe in	111	Using Unshielded Test	40
Supply, Ripple in	109	Limitations of Voltage-Doubler	
Holder for Probes	153	Probe	52
Horizontal:		Linearity, Adjusting TV	94
A.F.C. Testing	90	Load End	59
Deflection Coils, Checking	81	Load, Nonresonant	30
Output Transformer, Defects in	108	Loading Circuit	75
Sweep Circuits	111	Locating a Beat Marker	41
Hot Spots	48	Locating a Dead Stage	30
Housing for Probes	159, 198	Locating Hum	195
Hum:		Locating Weak Stage	28
Location of	195	Locking of Generators	175
Probe	139	Losses, Transmission Line	70
Probe, Using the	139	Low-Capacitance Probe:	
I-Channel Synchronous Detector		Adjustments	78, 87
Response	170	Building a	96
I.F.:		Description of	75
Alignment	29	Designing a	78
Amplifier Pattern	29	Low Frequency Response of	
Buzz in Sound	33	Chrominance Circuit	174
Gain	29	Magic-Eye Probe	155
Selectivity	30	Maintenance of Chromatic Probe	174
Signal Tracing	54	Major Beats	43
Stage, Response of Single	32	Marker:	
Tracing Buzz in Sound	33	Accuracy	42
Impedance:		Beat	41
Characteristic	48	Generator, Calibration of	42, 54
Crystal	21	Generator Harmonics	43
Generator	73	Indication	129
Input, at High-Channel		Markers:	
Frequencies	47	False	28
Matching	59	Sharpening	129
Matching of Cable	48		

Marking Ratio-Detector			Cathode Follower	160,	192
S-Curve	41,	54	Chromatic		165
Matching of Impedances		59	Circuit Time Constants		15
Matching Pads		30	Coil, Tuned		34
Maximum Input to Demodulator			Combined		132
Probe		10	Crystal Demodulator		7
Maximum Signal Voltage		47	D.C.		124
Measurements, Peak-to-Peak			Design		78
Voltage		56	Detector		8
Measurements with Crystal Probes		21	Direct	123,	132
Measuring D.C. Voltages		127	Divider		105
Measuring Probe Attenuation		76	Filter Characteristics		11
Meter Calibration, Effect of			Flatness of		11
Probe on		125	Frequency-Compensated		143
Meter Sensitivity		126	Frequency Range of Crystal		12
Miniature Test Probes		147	Grid Dip		196
Minor Beats		43	Grid Leak Detector		193
Mismatch of Impedances	61,	69	Grounding the		20
Mixing, Nonlinear		165	Gun		160
Modulated Carrier Wave Display		174	High-Frequency		184
Multiplication Factor of Probe		116	High-Voltage		99
Multiplier Probe, High-Voltage		115	High-Voltage Multiplier		115
Multiplier, Probe, Using the		116	Housing		198
Multitester, Input Resistance of		126	Hum		139
Multitester, Using Probe with		126	Input Voltage to Demodulator		12
			Isolation	123, 124, 128,	132
Negative Feedback in Probe		192	Isolation for Scope		128
Neon-Bulb Probe		158	Low-Capacitance		75
Noise		14	Low Capacitance,		
Nonlinear Mixing		165	Adjusting the		87
Nonresonant Load		30	Magic-Eye		155
Nonsinusoidal Waveforms, Basic			Measuring Attenuation of		76
Properties of		86	Miniature Test		147
Nonsymmetrical			Multiplication Factor		116
Waveshape	20, 83,	84	Neon Bulb		158
			Peak Indicating		184
Operation, Erratic		20	Peak-to-Peak	52,	190
Oscillator, Blocking		91	Quadrupler		154
Oscilloscope or V.T.V.M.?		20	Requirements, Crystal		11
Oscilloscope, Preamplifier for		16	Resistance		116
Oscilloscope (see also scope)			Response of		82
Output:			R.F.		184
Cable, Termination of		48	R.F. Indicator		149
of Probe, D.C.		184	R.F. Voltmeter		150
of Sweep Generator, Checking		44	Sensitivity		14
Video Amplifier		35	Shielding the		12
Overloading Scope Amplifier		45	Subminiature Tube		187
			Transistor		162
			Tube	183,	202
			Voltage-Doubler		51
Pads, Matching		30	Probes:		
Pattern, I.F. Amplifier		29	Balanced, Construction of		70
Peak Crystal Voltage		23	Handling		135
Peak Indicating Probe		184	Holder for		153
Peak Signal Voltage		47	Housing for		159
Peak Surges		38	in High-Impedance Circuits		79
Peak-to-Peak:			in High-Voltage Circuits		81
Probe	52,	190	in Sixty-Cycle Circuits		106
Probe for V.T.V.M.		53	Interchangeability of		23
Probe, Operation of		190	Specialized		137
Tests		21	Properties of Nonsinusoidal		
Voltage		84	Waveforms		86
Voltage Measurements		56	Pulse Voltages		82
Waveforms		21	Pulse Voltages, Sync		52
Peak Voltage vs. D.C. Output		185	Pulse Wave		82
Peaked Sawtooth		86	Q Synchronous Detector Response		170
Phase Distortion		39	Quadrupler Probe		154
Picture, Smearly		39			
Plugs		156	Radio Servicing with a		
Portable Signal Tracer		199	Demodulator Probe		26
Potential, Contact	12,	183	Range, Voltage, of Probe		90
Power Supply, Ripple in High-			Ratings, Crystal Diode Current		36
Voltage		109	Ratings, Crystal Diode Voltage		36
Preamplifier for Scope		16	Ratio-Detector Curve,		
Precautions, Safety		119	Marking a	41,	54
Probe:			Reactance, Excessive, in Flyback		
Adjustment of Low-Capacitance		78	Transformer		108
A.F. and R.F. Tracer		144	Receiver Service Checks		27
Amplifier		143	Receivers, Signal Tracing AM		189
Audio Tracer		137	Receivers, Signal Tracing FM		190
Attenuation		75	Rectification of Signal		26
Balanced		59			
Capacitance-Divider		99			
Capacitor Tester		140			

Reference Line, Zero-Volt	63	Tracing, Signal Source in	55
Reflection of Signal	60	Tracing, Sweep	29
Regeneration	55	Tracing, Sync	90
Regenerative Stage	28	Voltage, Maximum	47
Rejection, Sixty-Cycle	57	Voltage, Video	35
Requirements of Crystal Probe	11	Sine Wave	83
Resistance of Multitester, Input	126	Sine Wave, R.M.S. Value of	84
Resistance of Probe, Calculating	116	Single I.F. Stage, Viewing	
Resistors, Isolation	123	Response of	32
Resonant Circuits, Detuned by		Single-Image Response	167
Probe	187	Sixty-Cycle Buzz	33
Response:		Sixty-Cycle Circuits, Behavior of	
Booster	72	Probes in	106
Characteristics	14	Sixty-Cycle Rejection	57
Curves	167	Smeary Picture	39
Curves, Obtaining Video	168	Sound I.F. Strip, Buzz in	33
Frequency	56	Source of Supply	59
Probe	82	Specialized Probes	137
Scope	82	Spots, Cold and Hot	48
Single I.F. Stage	32	Spurious Markers	28
Single-Image	167	Square-Wave Bias for Sweep	
R.F.:		Oscillator	65
in Scope Input	45	Square-Wave Generator	
Indicator Probe	149	Frequencies	40
Input Voltage to Demodulator		Square-Wave Testing	39
Probe	12	Stage:	
Probe	184	Indication, Dead	55
Probe, Servicing TV with	188	Gain	28
Tracer Probe	144	Locating a Dead	30
Voltmeter Probe	150	Locating a Weak	28
Ring Delay Line	171	Regenerative	28
Ripple in High-Voltage Supply	109	Standing-Wave Distortion	48
R.M.S. Value of Sine Wave	84	Standing Waves on Cable	30
Root-Mean-Square Value of		Stubs	69
Sine Wave	84	Subminiature Tube Probe	187
Safety Precautions	119	Surge Impedance	48
Sawtooth, Peaked	86	Surges, Peak	38
Scope:		Sweep:	
Amplifier, Overloading	45	Circuits	111
as a Voltmeter	83	Coil Voltage	94
Calibration of	83, 84	Generator, Checking Output of	44
Distortion, Allowing for	83	Oscillator, Square-Wave	
Input Requirements	16	Bias for	65
Input R.F. in	45	Video	166
IRE Roll-off Characteristic of	83	Windings, Testing	81
Isolation Probe for	128	Sync:	
or V.T.V.M.?	20	Buzz	55
Preamplifier	16	Buzz Tracing	54
Response	82	Circuits	112
Uncompensated	106	Discriminator Efficiency	90
Voltage Input to	16	Signal Tracing	90
S-Curve	41, 54	Voltages	52
Selectivity, I.F.	30	Synchronous Detector Response,	
Sensitivity of Probe	14	I Channel	170
Sensitivity, Meter	126	Synchronous Detector Response,	
Series Detectors	10	Q Channel	170
Service Checks, Receiver	27	Termination of Cable	48
Servicing TV with the R.F. Probe	188	Test Leads	134
Servicing with Crystal Probes	25	Test Leads, Unshielded	40
Servicing with Demodulator		Test Leads, Using Open	132
Probe, Radio	26	Test Probes, Miniature	147
Sharpening Markers	129	Testing:	
Shielding the Probe	12	Color TV	55, 169
Short Ground Leads	46	Horizontal Deflection Coils	81
Shunt Capacitance of Video		Intermittent Capacitors	140
Amplifiers	38	Transmission Lines	66
Shunt Detectors	10	Video Amplifiers	35
Shunting Effects, Capacitance	75	with Square Waves	39
Signal:		Tests:	
Detection of	26	Color Circuit	179
Distortion of Composite Video	29	Peak-to-Peak	21
Reflections	60	Receiver Service	27
Source in Signal Tracing	55	Time:	
Tracer	201	Constant	16
Tracer for AM, FM, and TV	201	Constant of Isolating Probe	129
Tracer, Portable	199	Constants of Probe Circuit	15
Tracer, Tuned	201	Delay	39
Tracer, Using the	200	Transit	183
Tracing	27	Tolerances of Waveforms	111
Tracing, AM Receivers	189	Tracer:	
Tracing, FM Receivers	190	Audio Probe	137
Tracing, I.F.	54	for AM, FM & TV, Signal	201

Portable Signal	199	Video Signal Voltages	35
Probe, A.F. & R.F.	144	Video Sweep, Development of	166
Probe, Using the	146	Viewing Response of Single I.F. Stage	32
Tuned Signal	201	Visual Alignment	30
Tracing:		Volt, Zero, Base Line	44
Buzz Pulse in Sound I.F. Strip	33	Voltage:	
Hum	139	Adapter, High	95
I.F. Signal	54	at Video Input, D.C.	169
Signal	27, 55	Calibration of Scope	83
Sweep Signal	29	Contact	12
Sync-Buzz	54	Doubler Probe, Grounding the	53
TV Sync Signal	90	Doubler Probes	51
Transformer, Flyback, Excessive Reactance in	108	Input to Scope	16
Transistor Probe	162	Maximum Signal	47
Transit Time	183	Measurements, Peak-to-Peak	56
Transmission Line:		Measuring D.C.	127
Flatness of	61	Measuring High-Frequency	184
Impedance	66	Peak Crystal	23
Losses	70	Peak-to-Peak	84
Testing	66	Peak vs. D.C.	185
Trapezoid	83	Probe, Grounding the High Pulse	114
Tube Probe, Subminiature	187	Range of Probe, Extending the	90
Tube Probes	183, 202	Ratings, Crystal Diode	36
Tube Used as a Capacitor	100	Sync	52
Tuned Probe Coil	34	to Demodulator Probe, R.F. Input	12
Tuned Signal Tracer	201	Video Signal	35
TV:		Yoke	94
Linearity, Adjusting	94	Voltmeter Probe, R.F.	153
Servicing with the R.F. Probe	188	V.T.V.M.:	
Signal Tracer	201	Input Resistance of	124
Sync Signal, Tracing	90	Isolation Probe for	123
Testing, Color	55, 169	or Scope?	20
Waveforms	209	Peak-to-Peak Probe for	53
Unbalance	73	Wave:	
Uncompensated Scope	106	Display, Modulated Carrier	174
Undershoot	28, 108	Distortion, Standing	48
Unshielded Test Leads	40	Nonsymmetrical	83
Uses for Crystal Probes	25	Pulse	83
Using Detector Probes	8	Sine	83
Using Direct Probes	131	Waveforms:	
Using Unshielded Test Leads	40	Asymmetrical	20
Vacuum Tube Probes	183	Basic Properties of Nonsinusoidal	86
Vacuum-Tube Voltmeter (see also V.T.V.M.)		Errors	46
Input Resistance of	124	I.F. Amplifier	29
Isolation Probe for	123	Nonsinusoidal	86
or Scope?	20	Peak-to-Peak	21
Peak-to-Peak Probe for	53	Tolerances of	111
Vertical Blocking Oscillator Bias	127	TV	209
Vertical Blocking Oscillator, Testing the	91	Waves on Cable, Standing	30
Video Amplifier:		Waves, Testing with Square	39
Adjusting a	38	Weak Stage, Locating	28
Input, D.C. Voltage at	169	Wide-Band Sweep, Development of	166
Output	35	Y Channel	171
Shunt Capacitance of	38	Yoke:	
Testing a	35	Coils, Testing	81, 93
Video Response Curves, Obtaining	168	Current	93
Video Signal, Distortion of Composite	29	Voltage	94
		Zero-Volt Reference Line	44, 63, 65